

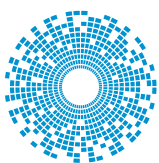

Power over Ethernet:
Physical Phenomena Due To Electrical
Contact Separation & Standards Update



stewart
CONNECTOR
a bel group

POWER OVER ETHERNET

Physical Phenomena Due To Electrical Contact Separation & Standards Update

INTRODUCTION

Power over Ethernet (PoE)

Power over Ethernet describes the ability to provide power over the same twisted pair Ethernet connection that would otherwise transmit only data. Transmitting power and data through a single network connection reduces installation cost by eliminating the need to run a separate AC power source. PoE becomes even more advantageous when running power to remote locations without readily available AC power or when moving previously installed PoE powered equipment. The installation and rearrangement of powered equipment is simplified to moving the equipment and plugging in the PoE powered Ethernet cable without the need of a licensed electrician.

The coming IEEE 802.3bt standard will introduce higher power PoE up to a maximum of 100 watts allowing for an expansion of connectable devices. Devices with relatively high power requirements such as flat-panel displays, high power wireless access points, and desktop computers can now run on PoE systems.

In addition, since the PoE system operates with DC current a common uninterrupted power supply can provide continuous power to the terminal device during disruptions from the power grid. This feature allows critical emergency equipment such as alarms, cameras, and emergency lighting to remain operational when they are needed the most.

PoE Nomenclature

PSE vs. PD

The Power Sourcing Equipment (PSE) refers to the device where power is injected into the PoE system. The power given for the PSE will be the greatest as this is where the power transmission begins within the PoE system. The Powered Device (PD) refers to the terminal device that is receiving the power in order to do some desired work. The power given for this device will naturally be lower because a portion of the power has been dissipated while moving through the PoE system.

PoE System

A PoE system consist of a single PSE, a single PD, and the link section connecting them.

Low Level Contact Resistance (LLCR)

LLCR is the measurement of small resistance values typically 1.0 Ohm or less by test methods designed to eliminate errors introduced by instrumentation such as the test leads themselves or the contact resistance between the leads and the material being measured. LLCR is an important consideration for connections within the PoE system that are exposed to mechanical wear and electrical discharge.

POWER OVER ETHERNET

Physical Phenomena Due To Electrical Contact Separation & Standards Update

STANDARDS UPDATE

The Institute of Electrical and Electronic Engineers (IEEE)

New PoE standards are being drafted to meet the strong demand for increased power supplied via Ethernet cables. The IEEE 802.3bt standards are expected to be ratified in Q1 of 2018 and will standardize two new PoE types, together they are called PoE++. Separately there will be type 3 and type 4 PoE++ with the difference being the amount of power supplied. The 802.3bt standards are still in draft form and therefore the details are subject to change but the general requirements are already agreed upon as outlined below.

TABLE 1. IEEE PoE Standards

Year Ratified	Type	IEEE PoE Standards	Number of Energized Pairs	Nominal Highest Current per Pair	Power (PSE)	Power (PD)
2003	PoE	IEEE 802.af Type 1	2	0.35 A	15.4 W	12.95 W
2009	PoE+	IEEE 802.at Type 2	2	0.60 A	30 W	25.5 W
Exp. Q1 2018	PoE++	IEEE 802.3bt Type 3	2 or 4	0.60 A	60 W	51 W
Exp. Q1 2018	PoE++	IEEE 802.3bt Type 4	2 or 4	0.96 A	100 W	71.3 W

It's unlikely that future PoE standards will increase the power supplied over 100 Watts as keeping power below the 100 W threshold maintains a level that is non-life threatening to humans. This means there is no requirement for a licensed electrician to install a PoE system and it can be rearranged as needed, although type 4 PoE will be addressed by the National Electric Code as discussed in the next paragraph.

2017 National Electric Code (NEC)

The 2017 edition of the National Electric Code will address PoE++ above the 60 W level. This means any PoE installations that are type 1, type 2, or type 3 will be unaffected by the National Electric Code. The only time the NEC will come into play will be in type 4 PoE installations that are by definition greater than 60W at the PSE.

TABLE 2. 2017 NEC Guidance

Type	IEEE PoE Standards	Power (PSE)	2017 NEC Applicable
PoE	IEEE 802.af Type 1	15.4 W	No
PoE+	IEEE 802.at Type 2	30 W	No
PoE++	IEEE 802.3bt Type 3	60 W	No
PoE++	IEEE 802.3bt Type 4	60 to 100 W	Yes

The 2017 NEC now recognizes limited power (LP) cables as designated by Underwriter laboratories (UL) to be used in type 4 PoE permanent installations. The use of LP cables is not mandatory however if LP cables are not used then the PoE installation is subject to inspection by the relevant authority's having jurisdiction (2017 NEC: section 725.144).

POWER OVER ETHERNET

Physical Phenomena Due To Electrical Contact Separation & Standards Update

International Electrotechnical Commission (IEC)

IEC 60512-99-001 standardizes a test method that evaluates the connector contacts used within a PoE system before and after operations while under electrical load and will be discussed in more detail within this paper. The 60512-99-001 standard pertains to type 1 and type 2 PoE systems and is limited to the associated wattages. Therefore the standard is currently being updated and has been designated as IEC 60512-99-002. This standard is expected to be ratified shortly and will be similar in method but modified to address the increased power utilized in type 3 and type 4 PoE systems. This should be in place before the IEEE 802.3bt standard is issued.

Telecommunications Industry Association (TIA)

The TIA is currently working on TSB-184A that will address PoE applications and should also be completed shortly. The Technical Systems Bulletin or “TSB” is intended to provide guidelines for remote powering over twisted pair cabling in addition to but not replacing the ANSI/TIA-568 Standards. The TSB-184A document does not cover mating and un-mating under load (i.e. potential degradation of connector contacts) as discussed within this paper, instead the document refers to the IEC 60512-99-002 that as mentioned will be ratified in the near future. The TSB does cover other critical parameters of the PoE system such as T-rise in cables bundles, DC loop resistance, DC resistance unbalance, and power loss due to cables (i.e. copper losses).

PHYSICAL PHENOMENA DUE TO ELECTRICAL CONTACT SEPARATION

Power over Ethernet requires connectors that are not only able to transmit data but also transmit power without interruption. Standard operation requires the plugs and jacks within the PoE system to be mated and unmated regularly without degradation. There are two main concerns regarding the physical degradation of the connector contacts.

- Effects caused by mechanical abrasion and environmental exposure.
- Effects caused by electrical discharge (spark and corona discharge).

There are two potential short term effects to cause concern; damage to the contacts from the mechanical force and damage to the contacts from the electrical force. Additionally there is a long term concern due to corrosion after the surface of the contact has been degraded. There are two tests performed by Stewart Connector to address these concerns.

- Mechanical operations without load (IEC 60603-7). For level one, connectors must exceed 750 cycles with a maximum change of 20 mΩ as measured using the LLCRC method.
- Mechanical operation with electrical load (IEC 60512-99-001/IEC 60512-99-002).

The acceptance criteria for both tests is a maximum change of 20 mΩ in Low Level Contact Resistance (LLCR). The LLCRC test method is shown below. For both tests, the mechanical operations without load and with load the LLCRC measurements are to be taken before and after cycling. Passing both tests requires the change in LLCRC to be less than 20 mΩ. There are other tests within the test groups according to the respective standards but for our purposes within this paper we will discuss the steps of the test directly related to PoE and possible contact degradation.

POWER OVER ETHERNET

Physical Phenomena Due To Electrical Contact Separation & Standards Update

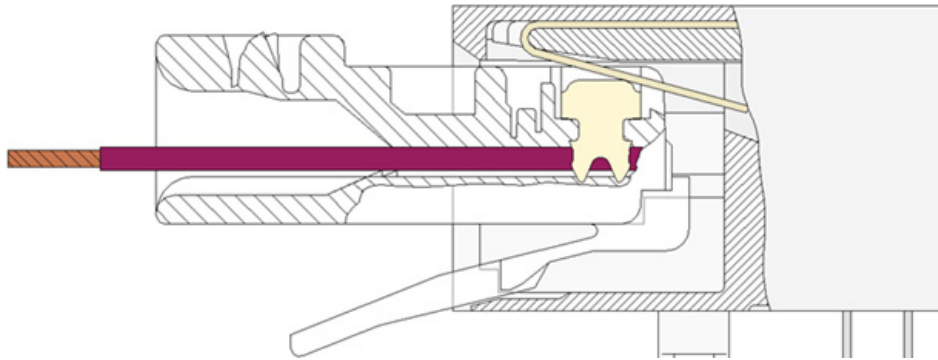

Figure 1. LLCR test method

Low Level Contact Resistance (LLCR – bulk)

- Consists of four components
- Plug Conductor Resistance
- Plug Blade/Conductor Contact Resistance
- Plug Blade/Jack Wire Contact Resistance
- Jack Wire resistance

Mechanical operations without load (IEC 60603-7)

The mechanical operations without load test is performed as the name states without electrical load and essentially represents normal mating and un-mating of the connector at a set speed (10 mm/s) as described under test phase BP 2 in IEC 60603-7. After half of the cycles (375) are performed the samples are exposed to mixed flowing gas and then cycled an additional 375 cycles for 750 total. The acceptance criteria is a maximum change in LLCR of 20 mΩ. Upon visual inspection there will be noticeable wear but physical appearance is not the acceptance criteria, a change in resistance is. The test data in figure 2 is typical of the observed change in LLCR on Stewart Connector jacks as tested according to IEC 60603-7. Maintaining a low resistance electrical connection while the connector is frequently mated and unmated is critical to providing a reliable PoE system. All of Stewart Connector's PoE components are tested to meet and exceed this requirement.

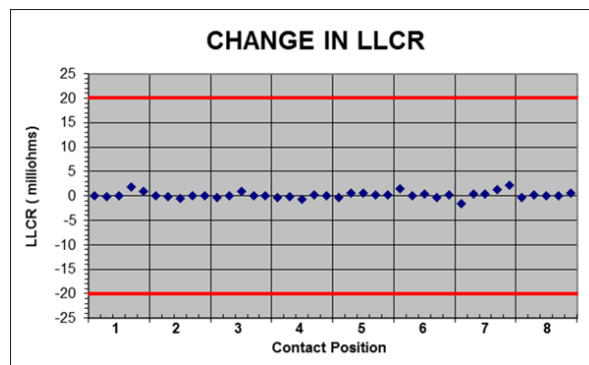

Figure 2. Change in LLCR after 750 cycles without load.

POWER OVER ETHERNET

Physical Phenomena Due To Electrical Contact Separation & Standards Update

Mechanical Operation with Electrical Load (IEC 60512-99-001/002)

The IEC 60512-99-001 standard will soon be replaced by IEC 60512-99-002 but as of now the -002 standard is in draft form so we will discuss the -001 standard first. The purpose of this test is to subject the connector contacts to the effects caused by electrical discharge and to evaluate them based on change in resistance. The open circuit voltage is 55 V dc with a test current of 0.6 A. This current level would apply to type 1 through type 3 PoE systems which carry a maximum of 0.3 A per conductor and 0.6 A per pair. The test current is doubled to 0.6 Amps to reflect the possibility of one contact lifting off before the other conductor within the same pair. One interesting item to note is that ½ of the cycles in the test will be energized while the connector is both un-mated and while the connector is mated (test phase U.EL. 1.8). The connector being energized while mating is a worst case scenario and is unlikely to occur with regularity in the field. For this reason, the standard makes the energized while mating test phase optional, however if this portion of the test is not done it requires the omission of the test to be reported in all test reports produced. Both of the energized conditions utilized in this standard are illustrated in figure 3 below. Stewart Connector PoE components comply with all portions of this test.

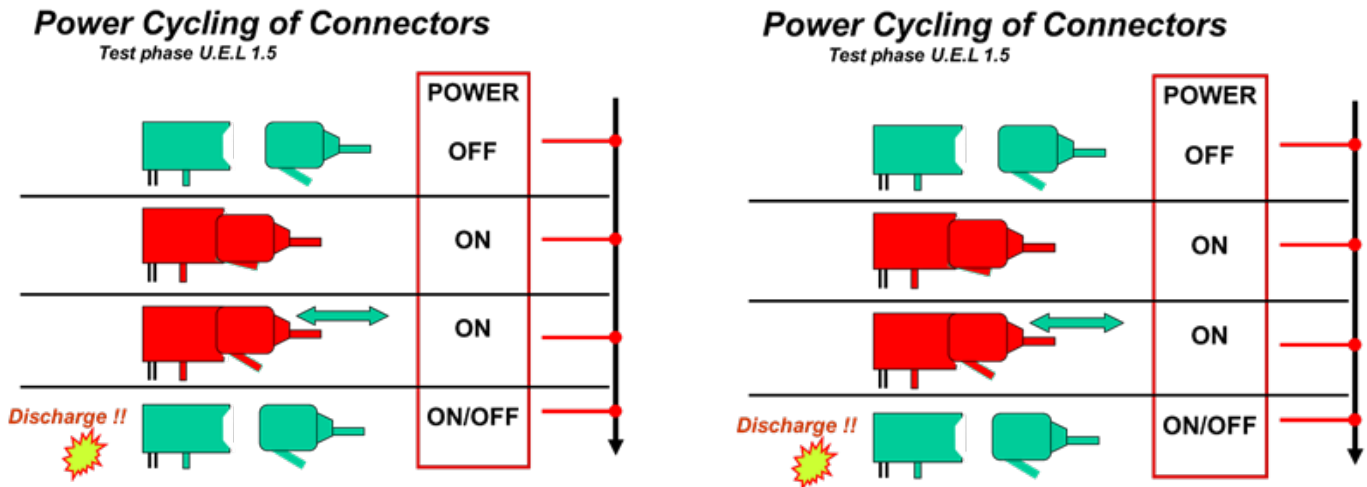

Figure 3. IEC test method Illustrations

As mentioned IEC 60512-99-002 will be ratified shortly and will essentially be the same test sequence and method as found in the IEC 60512-99-001 standard but with increased current to represent conditions found within a type 4 PoE system.

CONTACT DEGRADATION IS DEPENDENT ON CONNECTOR DESIGN

The connectors design will directly impact the ability to survive the mechanical operations with and without load as described previously. The greater the distance between the connect-disconnect location and the nominal contact area (where the connector rests when in operation) the less effect on LLCR due to the physical phenomena of electrical discharge. Stewart Connector plug and jack designs take this into account and maintain enough distance to prevent damage to the nominal contact area.

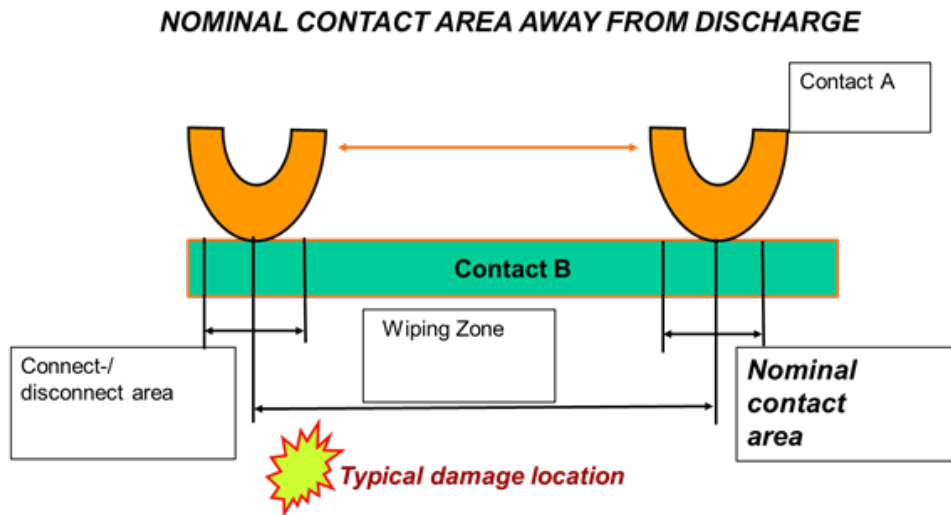

Figure 4. Nominal contact area located away from discharge

As you can see in figure 5 the damaged caused by electrical discharge is contained primarily within the initial connect area and not in the wiping zone or the nominal contact area.

Typical effect of Electrical Discharge

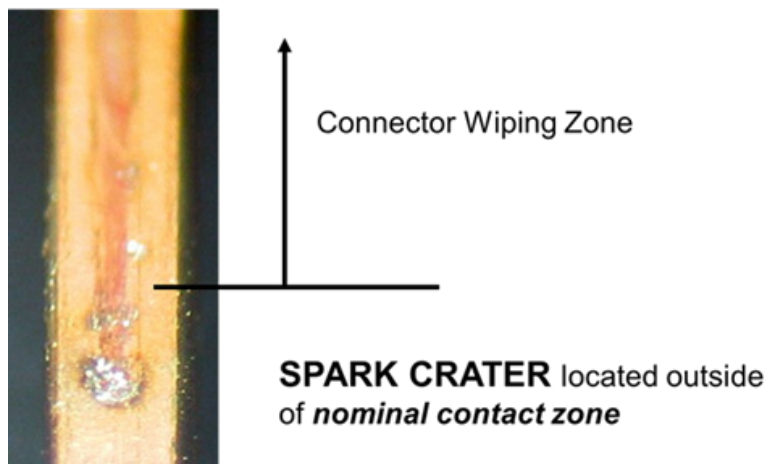

Figure 5. Typical effect of electrical discharge

POWER OVER ETHERNET

Physical Phenomena Due To Electrical Contact Separation & Standards Update

EXAMPLES OF STEWART CONNECTOR CONTACTS DESIGNED FOR PoE APPLICATIONS

RJ45 Contact Design

The 8P8C modular plug and jack design is commonly referred to as an RJ45 connector and is the most widely recognized Ethernet connector system. This connector system supports a wide range of data transmission speeds from category 3 to category 8 as defined in TIA-568-C.

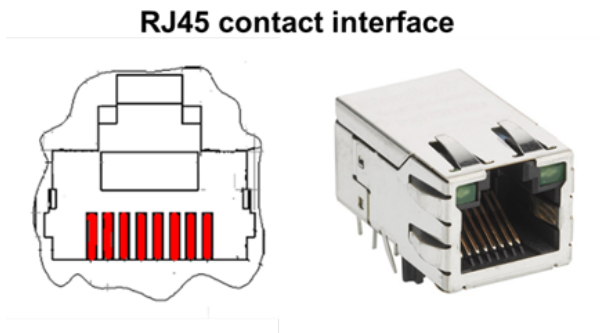

Figure 6. RJ45 contact design

Figure 7 illustrates the discharge sequence for the Stewart Connector RJ45 connector system. The first picture shows the plug and jack contacts at the nominal contact area as it is during normal operation. The second picture shows the plug and jack contacts as the plug is being withdrawn from the jack causing an electrical discharge at the connect-disconnect area. The third picture shows the plug and jack contacts in the unmated state. As the picture illustrates the discharge area is separated from the nominal contact area.

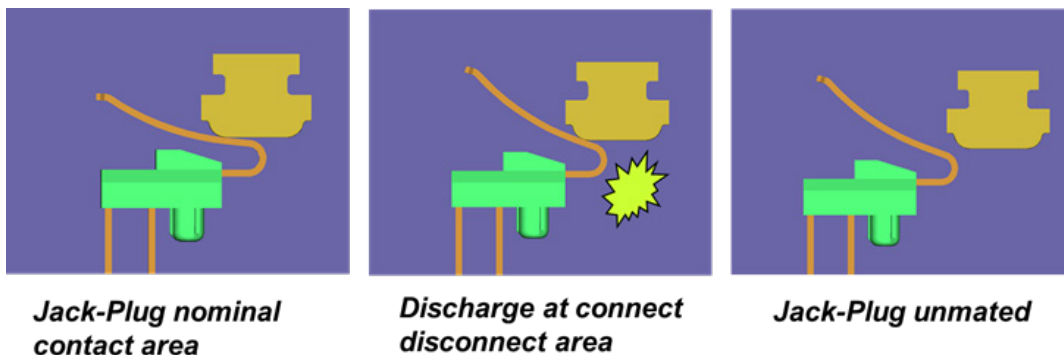

Figure 7. RJ45 discharge sequence

Figure 8 details contact degradation caused by electrical discharge at the connect-disconnect area. The contact design works as intended not by preventing contact degradation but by ensuring that it remains outside of the nominal contact area. As can be seen in the second picture there is clearly a ‘wiping zone” where the plug contact travels across the surface of the jack contact and where the wiping ends there is a crater caused by an electrical spark. This is the first and last place where the plug and jack make contact and will not affect the resistance between the two contacts during normal operation.

POWER OVER ETHERNET

Physical Phenomena Due To Electrical Contact Separation & Standards Update

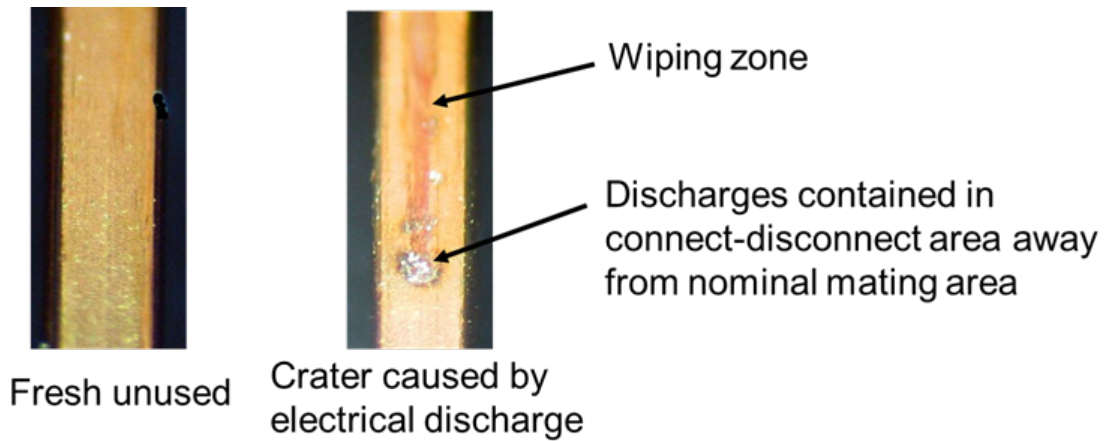
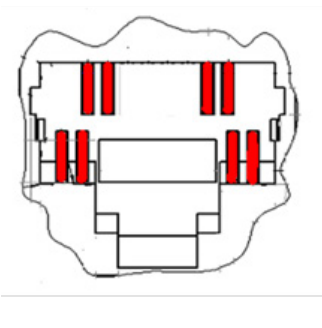

Figure 8. RJ45 electrical discharge before and after

ARJ45 Contact Design

The ARJ45 connector system is designed for high speed data transmission environments meeting category 7a performance standards up to 3000 MHz as defined by IEC61076-3-110:2016 and category 8.2 performance as defined in ISO/IEC 11801-99-1. Although the ARJ45 connector system is designed for high speed data transmission it must also meet PoE requirements.

ARJ45 contact design & interface



ARJ45 CableJack

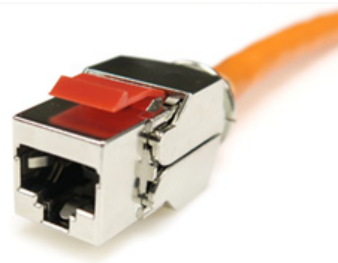

Figure 9. ARJ45 contact design and ARJ45 CableJack

POWER OVER ETHERNET

Physical Phenomena Due To Electrical Contact Separation & Standards Update

Figure 10 below details the ARJ45 connector plug and jack mating cycle. This cutaway view illustrates how through proper design the electrical discharge can be separated from the nominal contact area.

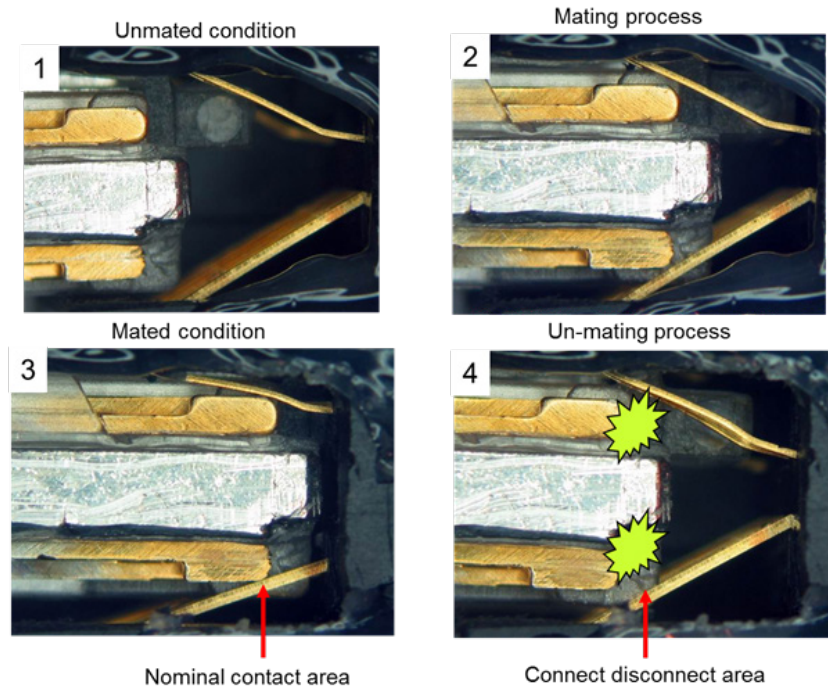

Figure 10. ARJ45 mating cycle

Figure 11 details contact degradation caused by electrical discharge on the top and bottom portions of the interface. Although damage does occur the damage remains separated from the nominal contact area by the contacts design maintaining a low resistance interface between plug and jack during operation.

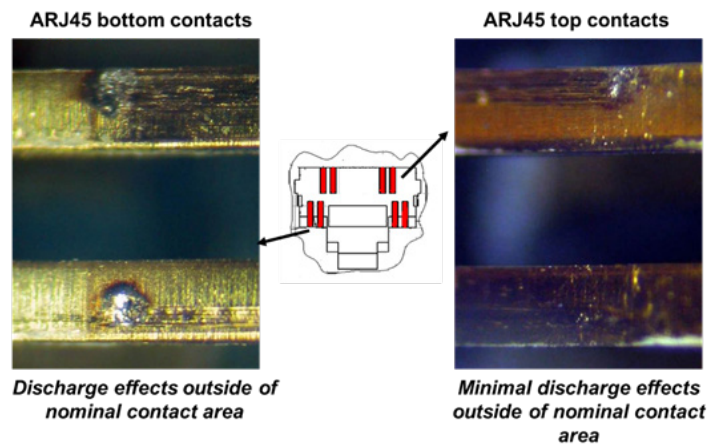

Figure 11. ARJ45 electrical discharge effects

RJ point five Contact Design

The RJ point five connector system is designed to increase port density providing nearly double the port density of the traditional RJ45 connector system. RJ point five connectors are intermateable and interoperable with other IEC 62946 series connectors. As with the RJ45 and ARJ45 systems the RJ point five system must meet the PoE requirements and were designed to achieve not only the technical requirements allowing high port density but also for survivability when operating within a POE system.

Comparison of RJ45 and dual port RJ point five



Figure 12. RJ point five comparison with RJ45

RJ point five contact design

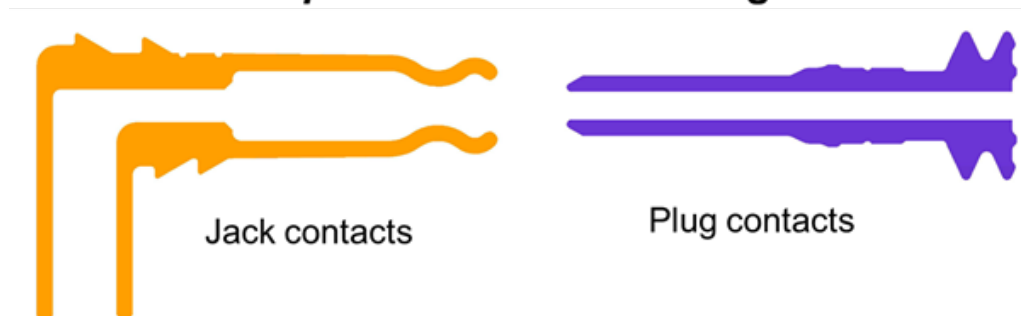

Figure 13. RJ point five contact design

Figure 14 illustrates the discharge sequence for the RJ point five connector system. Once again we can observe how a properly designed contact will separate the electrical discharge from the nominal contact area. The unique double bend contact design creates an intentional discharge area at the tips of the contact that is lifted away from the mating plug contacts as the connector moves into the nominal mating position. This provides two distinct surfaces one for electrical discharge and one for operational performance.

*RJ point five is a trademark owned by TE Connectivity used here under license.

POWER OVER ETHERNET

Physical Phenomena Due To Electrical Contact Separation & Standards Update

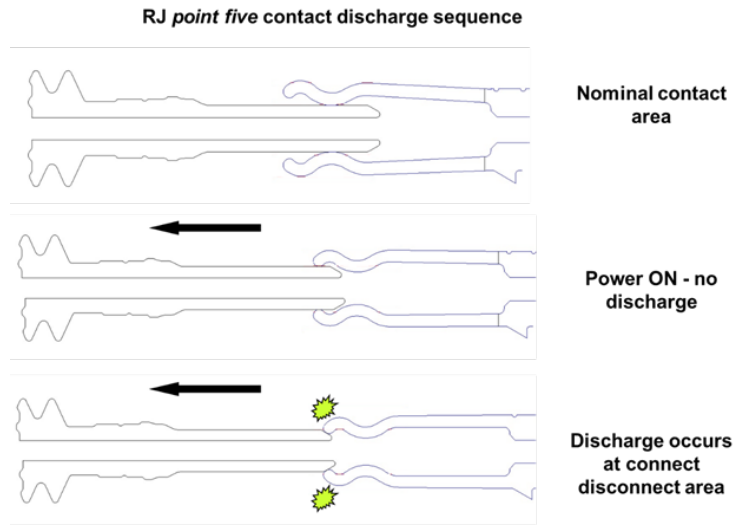

Figure 14. RJ point five discharge sequence

Figure 15 details the results of the connector design after use within a PoE system. The ends of the contacts have been damaged by electrical discharges while the nominal mating areas are free from the discharge effects. The mating surfaces have visible wear from the mechanical cycling of plug and jack contacts, but the wear is normal and meets the requirements of the mechanical operations without load test as specified within IEC 60603-7.

All discharges are contained within connect disconnect area

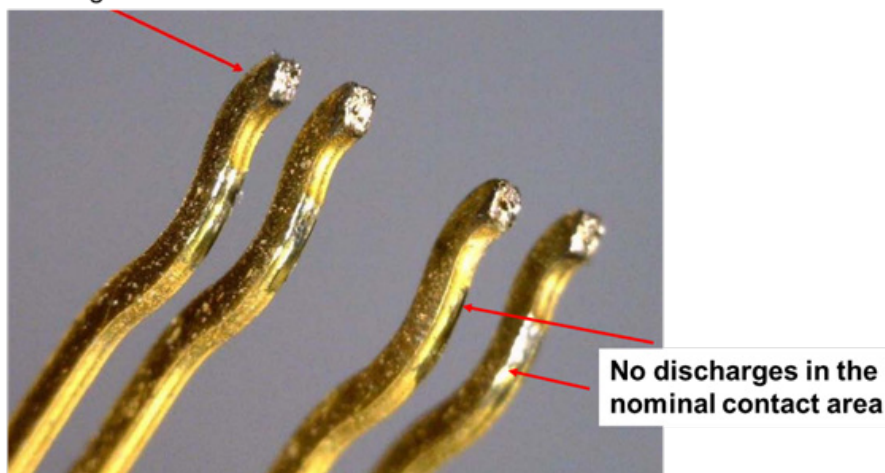

Figure 15. RJ point five electrical discharge effect

CONNECTOR CURRENT RATING

Current rating describes the relationship between temperature and current as measured at the connector interface. As current increases, the temperature within the connector will also increase due to greater power dissipation. When selecting a connector for use within a PoE system and in particular a PoE++ system the connector must be designed and tested to meet the current rating requirements as per IEC 60603-7. The current de-rating curve shown in figure 16 specifies a maximum current given a particular ambient temperature, the equation for the de-rating curve is $I_t = 1.76 (-t/90)^{0.5}$.

Stewart Connector designs all of its connectors to operate under the de-rating curve and tests all connector designs at the nominal ambient temperature of 25°C (77°F). This means with an ambient temperature of 25°C the connectors are rated to handle a current of 1.5 Amps, well above the maximum 0.960 Amps present in PoE++.

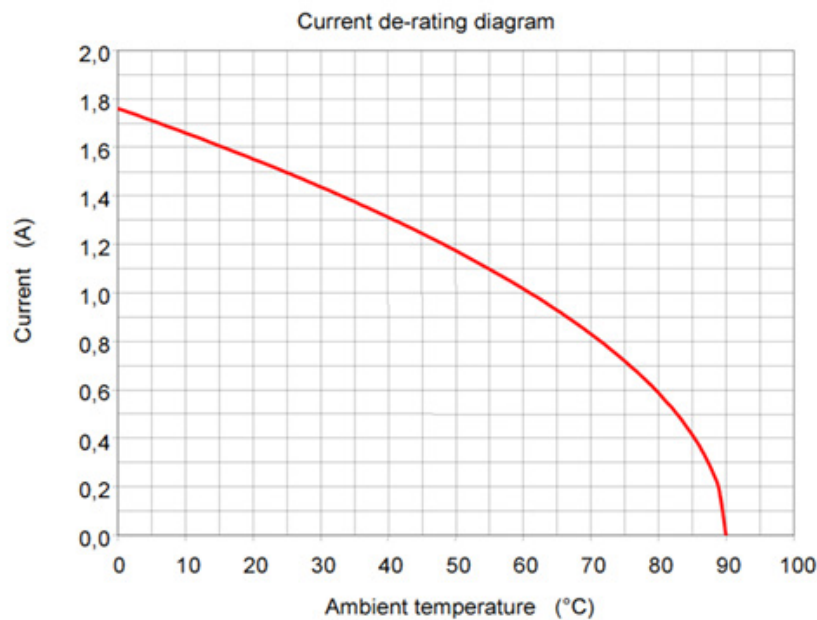

Figure 16. Current de-rating curve from, IEC 60603-7 Ed. 3.0

In conclusion, the increased power available with type 3 and type 4 PoE++ systems notably expands the utility of Power over Ethernet. Now devices with relatively high power requirements can be networked into a PoE system such as flat screens, pan-tilt-zoom cameras, intelligent LED lighting, emergency lighting, point of sale terminals, and many more uses that will develop now that the technology has been standardized. Of course with all of the positives there will be some possible negative side effects. As we have discussed the increased power has the potential to cause much greater damage to connector contacts when un-mating under load, potentially resulting in a highly resistive electrical interface that would only get worse with use and time. However, this can be mitigated through proper connector selection and testing.

POWER OVER ETHERNET

Physical Phenomena Due To Electrical Contact Separation & Standards Update

SUMMARY

All four of the standards organizations we have discussed the TIA, IEEE, IEC, and the NEC will have new standards out this year or early next year dealing with type 3 and type 4 PoE applications.

Copper cabling systems are best suited to support Power over Ethernet and data transmission.

The increased power of type 3 and type 4 PoE applications brings many new opportunities but also new concerns. Not all connectors are designed to withstand the electrical discharge present in type 3 and type 4 PoE applications.

It is recommended that all connectors used within a PoE systems installation have been tested for and exceed both the mechanical operation without load (IEC 60603-7) and mechanical operations under load (IEC 60512-99-001/002) test.

Stewart Connector's connectivity products are designed and tested to meet or exceed the applicable IEC, IEEE, and TIA standards.

All connectors manufactured by Stewart Connector are rated for 1.5 Amps with an ambient temperature of 25°C, exceeding the maximum current present in PoE++ applications.

Always select a connector that has been designed to provide separation between the connect-disconnect contact surface and the nominal mated contact surface.

AUTHOR

Mark Ellis, Test Engineer, Research and Development

Stewart Connector | a bel group

mark.ellis@belf.com

List of Applicable Standards

IEC 60512-99-001 Ed. 1.0. Connectors for electronic equipment - tests and measurements – Part 99-001. Test schedule for engaging and separating connectors under electrical load.

IEC 60512-99-002 Ed. 1. Committee Draft. Connectors for electronic equipment - tests and measurements – Part 99-001. Test schedule for engaging and separating connectors under electrical load.

IEC 60603-7-1 Ed.3.0. Connectors for electronic equipment. Part 7-1. Detail specification for 8-way, shielded, free and fixed connectors.

IEC 61076-3-110:2016 Ed. 3.0. Connectors for electronic equipment Part 3-110. Detail specification for free and fixed connectors for data transmission with frequencies up to 3 000 MHz

IEC 62946-01 Ed. 1. Connectors for electronic equipment Part 01. Rectangular connectors.

IEEE 802.3bt_33_D1.7. Draft Standard for Ethernet Amendment: Physical Layer and Management Parameters for DTE Power via MDI over 4-pair.

NFPA 70: National Electric Code (NEC) Handbook

TIA TSB-184A Draft 7.1. Guidelines for Supporting Power Delivery over Balanced Twisted-Pair Cabling.