

V2

Power Shelf

Power Module

Battery Back-up Unit

Bel Power Solutions 6600 W stand-alone **V2 Power Shelf** with a main 12.6 VDC output and a 54 VDC auxiliary output is powered from three-phase AC line and hosting three 3300 W (N + 1) hot-swappable single phase **V2 Power Modules** and three battery back-up units (BBU).

At System level, this device will work in conjunction with BBU modules (installed in the same shelf) for power back-up functions.

This product is used for IT Systems, for both reliable online & back-up power functions, offering high performance and very high efficiency and power quality.



Key Features & Benefits

- High efficiency > 95.9 % @ 277 VAC, 50% load
- High power quality (Power Factor and THD)
- Redundant (2+1) output 6600 W / 12.6 VDC with active current sharing
- Redundant (2+1) auxiliary output 600 W / 54 VDC
- Houses 3 x 3300 W power modules
- Houses 3 x 3600 W Lithium-Ion Battery Backup Modules supporting a 90 s back-up capability in case of AC outage
- Open compute (OCP) compliant
- 3 Phase 200 VAC – 277 VAC input to shelf
- Hot-plug capable
- Digital control for improved performance
- RS485 communication interface for control, programming and monitoring based on MODBUS V1.02
- Status LED with fault signaling



bel POWER
SOLUTIONS &
PROTECTION

a bel group

belfuse.com/power-solutions

1. ORDERING INFORMATION

PRODUCT	ORDERING CODE
3300 W Power Module	SPAFCBK-11G
6600 W Power Shelf	SPSFCBK-18
Power Module Blank Panel	SPSFCBK-12BP01
Battery Module Panel	SPSFCBK-12BP02

2. OVERVIEW

The SPAFCBK-11G AC/DC power module is a MCU/DSP controlled, highly efficient front-end power supply. It incorporates resonant-soft-switching technology to reduce component stresses, providing increased system reliability and very high power conversion efficiency.

The PFC stage is digitally controlled using a state-of-the-art digital signal processing algorithm to guarantee best efficiency and unity power factor over a wide operating range.

The main DC/DC stage (12.6 V / 3300 W) uses soft switching resonant techniques in conjunction with synchronous rectification. An active OR-ing device on the output ensures no reverse load current and renders the supply ideally suited for operation in redundant power systems.

The auxiliary DC/DC stage (54 VDC / 300 W) uses a soft switching resonant topology and is also protected with an active OR-ing device for maximum reliability.

The DC/DC converter from the battery input (3600 W) provides power to the internal high voltage bus and allows the outputs to continue up to 90 s during AC outage. The battery charger stage (52.5 V / 270 W) re-charges the battery backup unit (BBU).

Status information is provided with a front-panel LED. The RS485 bus allows full monitoring of the supply, including input and output voltage, current, power, and internal temperatures. The same RS485 bus supports the bootloader to allow field update of the firmware in the MCU and the DSPs.

The supply is cooled by a regulated fan and the air direction matches regular data center rack configurations. The fan speed is adjusted automatically depending on the supply temperature.

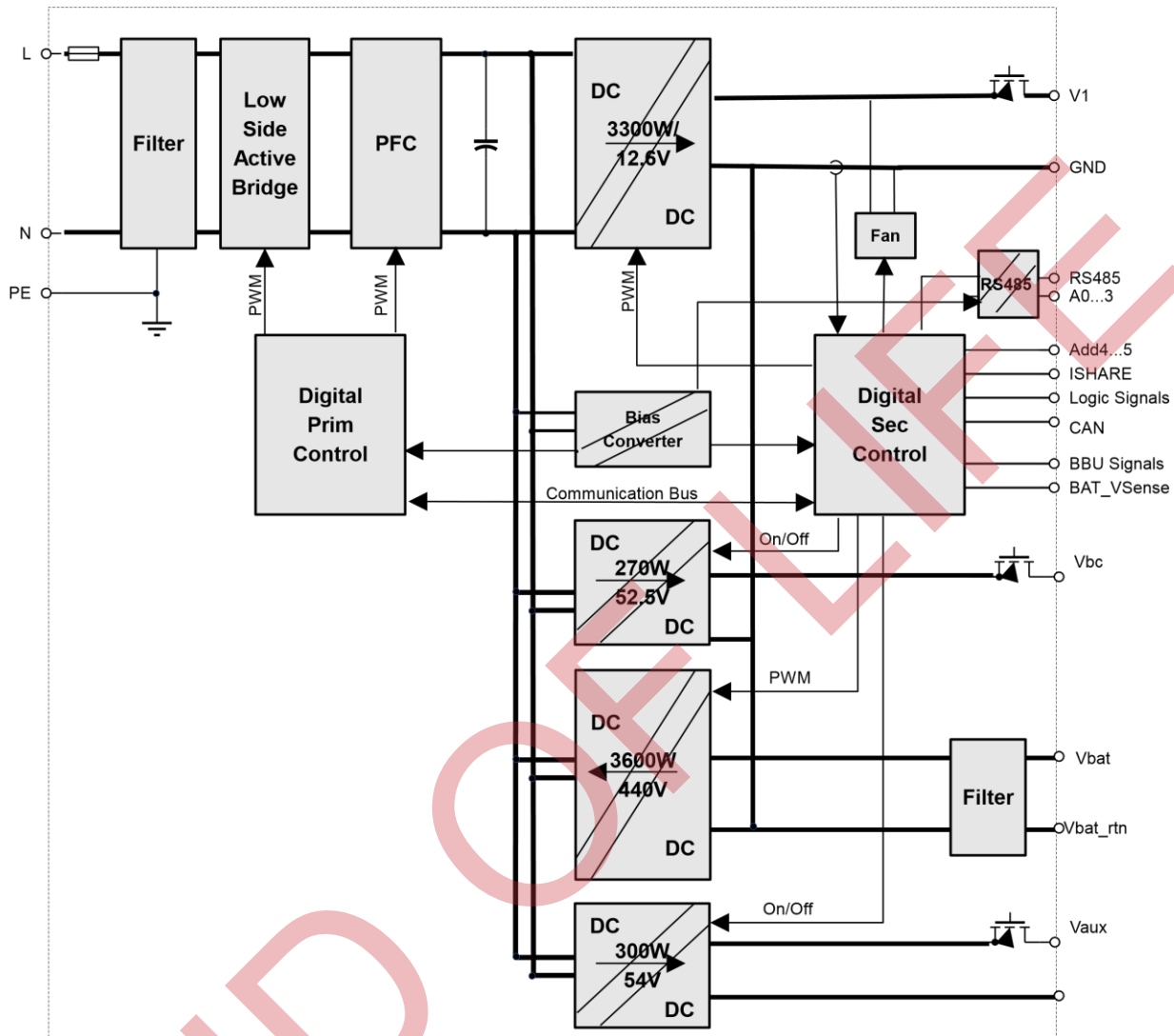

Figure 1. SPAFCBK-11G Block Diagram

The SPSFCBK-18 power shelf houses 3 power supply units (PSU) and 3 battery back-up units (BBUs) and maximizes power availability in demanding server, network, and other high availability applications.

The main 12.6 VDC output offers 6600 W power in 2+1 redundant operation on a single output busbar on the back side of the shelf, which is directly connected to the output busbar of all PSUs. Power balancing between the units is ensured by an active current share scheme.

The auxiliary 54 VDC output offer 600 W power in 2+1 redundant operation on a single output connector on the rear side of the shelf.

A wiring harness connects the PSU to the BBU and the power shelf. Each PSU has its own BBU and there is no direct interconnection between the BBUs.

V2 Power Module & V2 Power Shelf

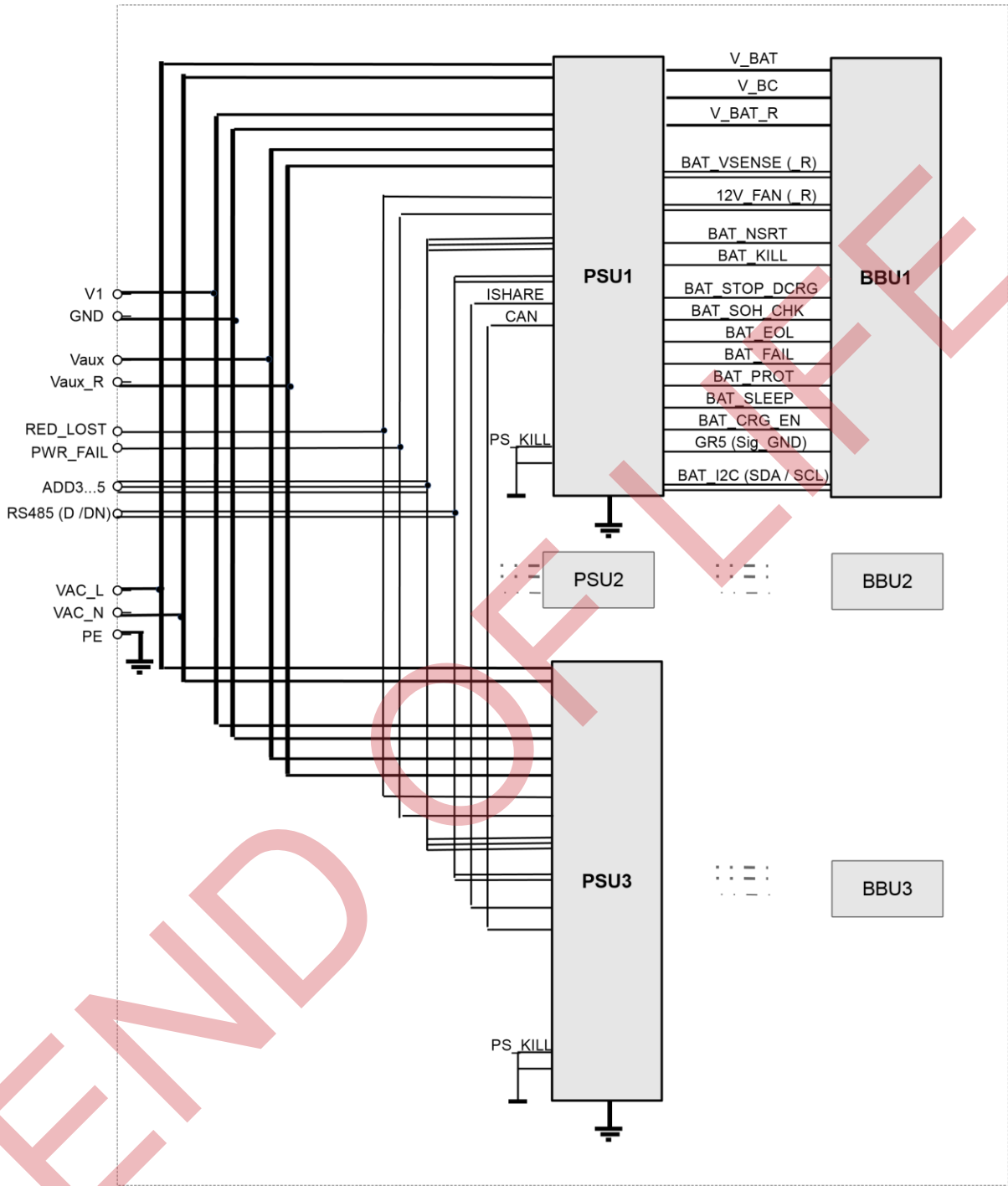

Figure 2. SPSFCBK-18 Block Diagram

In case some of the PSU or BBU are not populated in the shelf, the blank panels SPSFCBK-12BP01 (PSU) and SPSFCBK-12BP01 (BBU) can be assembled to cover the slots and avoid reverse airflow.

Blanking panels on request

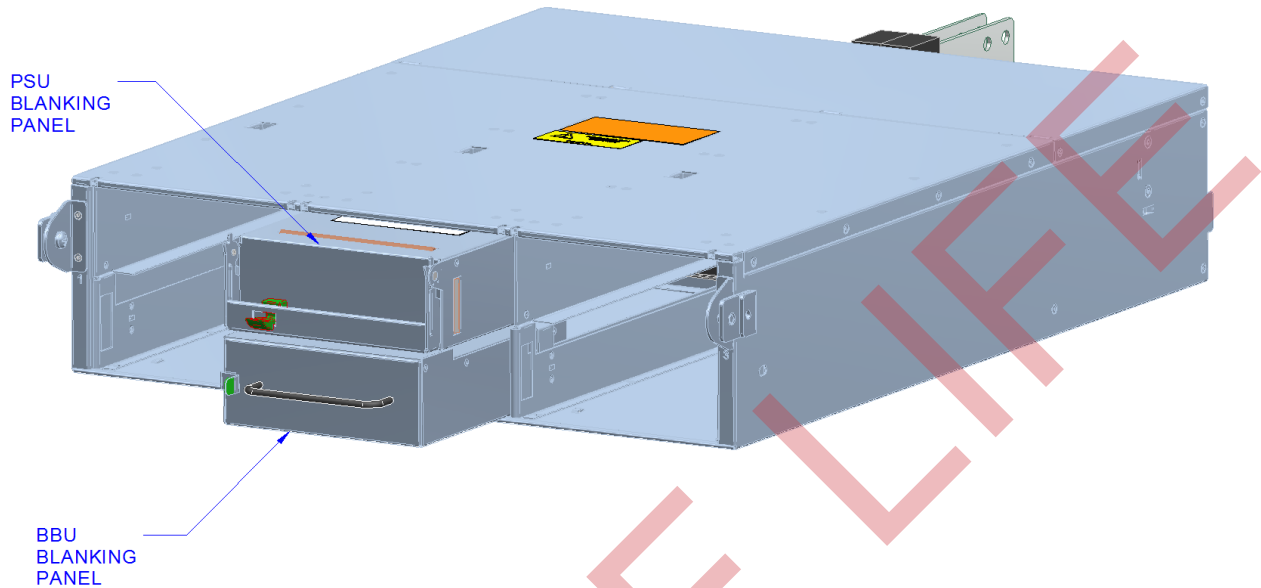

Figure 3. Shelf with Blanking Panels

3. V2 POWER MODULE



3.1 ABSOLUTE MAXIMUM RATINGS

Stresses in excess of the absolute maximum ratings may cause performance degradation, adversely affect long-term reliability, and cause permanent damage to the supply.

PARAMETER	DESCRIPTION / CONDITION	MIN	NOM	MAX	UNIT
$V_{i\ maxc}$	Maximum Input Voltage			305	VAC

3.2 INPUT

General Condition: $T_A = 0 \dots 45\ ^\circ\text{C}$ unless otherwise noted. Load condition definition: 100% load corresponds to the following, and any fraction of it is scaling down all outputs simultaneously.

- (i) Main 12.6 V: 3300 W + Auxiliary 54 V: 300 W + Battery Charger 52.5 V: 270 W in AC operation
- (ii) Main 12.6 V: 3300 W + Auxiliary 54 V: 300 W in DC operation

PARAMETER	DESCRIPTION / CONDITION	MIN	NOM	MAX	UNIT	
AC Input						
$V_{i\ ac\ nom}$	Nominal Input Voltage	200	277		VAC	
$V_{i\ ac}$	Input Voltage Range	180		305	VAC	
$I_{i\ ac\ max}$	Input Current		22.8		A	
$I_{i\ ac\ inrush}$	Inrush Current Limitation			30	A _P	
f_i	Input Frequency	40	50/60	63	Hz	
PF	Power Factor	>15% of max load, 277 VAC	0.95	0.966		W/VA
		20% Load, 277 VAC, 60 Hz		0.981		W/VA
		50% Load, 277 VAC, 60 Hz		0.996		W/VA
		100% Load, 277 VAC, 60 Hz		0.999		W/VA
THD	Total Harmonic Distortion		7.4	10	%	
$V_{i\ ac\ on}$	Turn-on Input Voltage ¹	171		180	VAC	
$V_{i\ ac\ off}$	Turn-off Input Voltage ¹	165.5		172.5	VAC	
H	Efficiency ²	$V_{IN} = 277\ \text{VAC}, 10\% \text{ load}$		93.81		%
		$V_{IN} = 277\ \text{VAC}, 20\% \text{ load}$		95.28		%
		$V_{IN} = 277\ \text{VAC}, 50\% \text{ load}$		95.96		%
		$V_{IN} = 277\ \text{VAC}, 100\% \text{ load}$		94.70		%
$T_{V1\ holdup}$	Hold-up Time V_1	$V_{IN} = 277\ \text{VAC}, \text{load } 3300\ \text{W} / 12.6\ \text{V}, 300\ \text{W} / 54\ \text{V}$	20			ms
		$V_{IN} = 277\ \text{VAC}, 100\% \text{ load}$		24		ms
$T_{VSB\ holdup}$	Hold-up Time V_{AUX}		20			ms
	BULK Capacitors Rating	@ 105 °C		500		VDC
$V_{on\ bias}$	Internal Bias Supply Startup	Correspondent to 140 VDC on the bulk capacitors		94	100	VAC

DC Input (from BBU)				
V _{idc nom}	Nominal Input Voltage	33.8	52.5	VDC
pV _{idc}	DC Input Voltage Range	32	53	VDC
I _{idc max}	Input Current @ steady state, V _{in} = 33.8 VDC		125	A

- ¹ The Front-End is provided with a minimum hysteresis of 8 V during turn-on and turn-off within the ranges
- ² Efficiency measured with Fan supplied externally and only main output loaded.

3.2.1 INRUSH CURRENT

The AC-DC power supply exhibits an X-capacitance of only 5.2 μF resulting in only a low and short peak current when the supply is connected to the mains. The internal bulk capacitor will be charged through an NTC which will limit the inrush current.

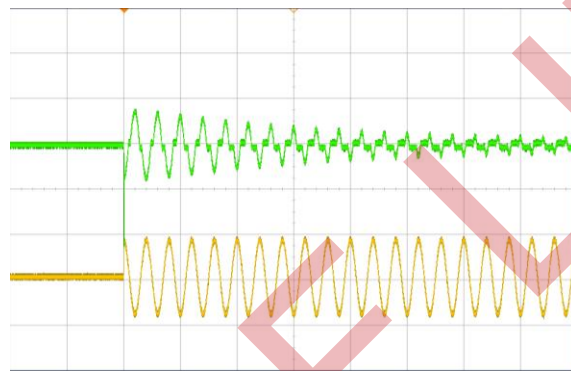

Figure 4. Inrush current, V_{in} = 290 VAC, 90°
CH1: V_{in} (500 V/div), CH2: I_{in} (10 A/div)

3.2.2 POWER FACTOR CORRECTION & THD

Power factor correction (PFC) is achieved by controlling the input current waveform synchronously with the input voltage. A fully digital controller is implemented giving outstanding power factor results over a wide input voltage and load ranges. The input current will follow the shape of the input voltage. If for instance the input voltage has a trapezoidal waveform, then the current will also show a trapezoidal waveform.

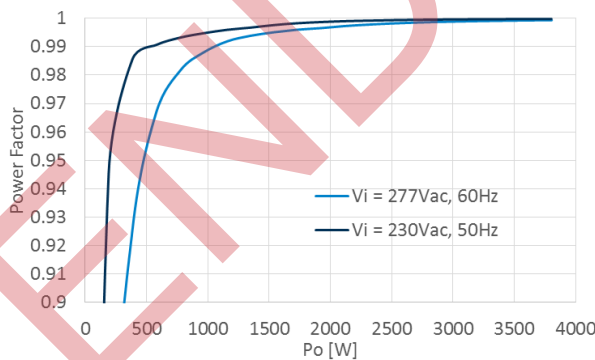

Figure 5. Power factor vs. Load current

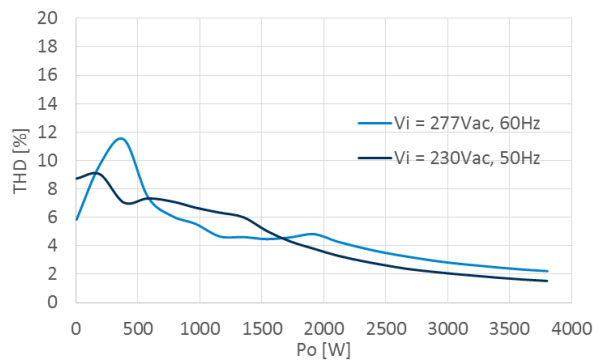

Figure 6. THD vs. Load current

3.2.3 EFFICIENCY

High efficiency (see *Figure 7*) is achieved by using state-of-the-art silicon power devices in conjunction with soft-transition topologies minimizing switching losses and a full digital control scheme. Synchronous rectifiers on the output reduce the losses in the high current output path. The speed of the fan is digitally controlled to keep all components at an optimal operating temperature regardless of the ambient temperature and load conditions.

Setup: Single unit in Shelf Slot1, VAC and V1 measurement at PCB level at the connector. Fan externally supplied. Only main output loaded.

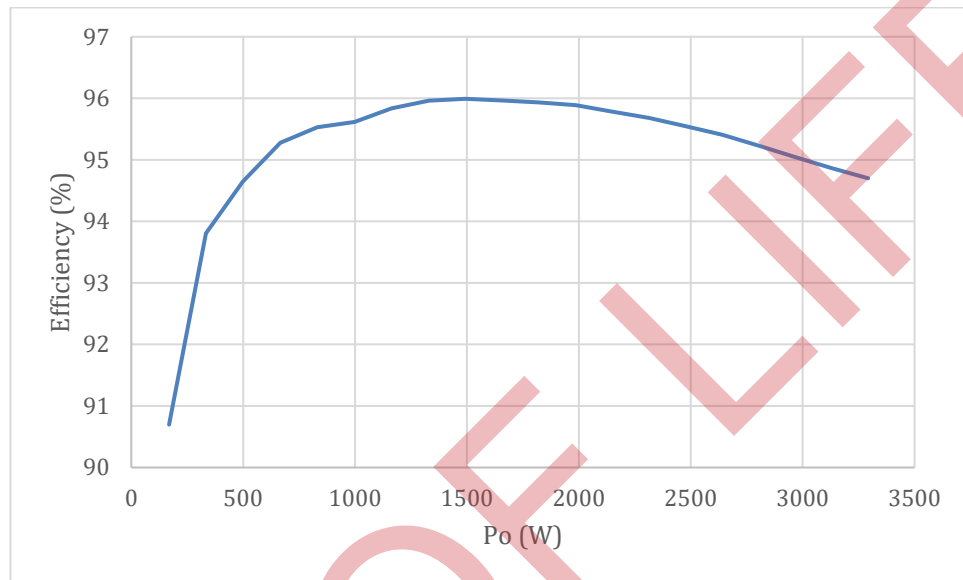

Figure 7. Efficiency vs. Load current in AC Operation; $V_{in} = 277$ VAC

3.2.4 HIGH VOLTAGE BULK CAPACITORS

The internal high voltage bulk capacitors which are charged through the PFC stage and in case of AC outage through the current feed converter from the BBU have a voltage rating of 500 VDC.

3.2.5 INTERNAL BIAS SUPPLY

The internal bias supply which is powering the control and communication circuit turns on at a AC input voltage level $V_{on\ bias}$. This is the minimum voltage required to be able to communicate to the unit.

3.3 OUTPUT

General Condition: TA = 0...45 °C unless otherwise noted.

PARAMETER	DESCRIPTION / CONDITION	MIN	NOM	MAX	UNIT
Main Output V₁ (12.6 V)					
V _{1 nom}	Nominal Output Voltage		12.6		VDC
V _{1 set}	Output Setpoint Accuracy	-1		+1	%V _{1 nom}
dV _{1 tot}	Total Static Regulation	-1		+1	%V ₁
P _{1 nom}	Output Power		3300		W
I _{1 nom}	Output Current		265		ADC
dV _{1 load}	Load Regulation		215		mV
dV _{1 line ac}	AC Line Regulation	-30	0	30	mV
dV _{1 line dc}	DC Line Regulation	-30	0	30	mV
dV _{1 lt}	Load Transient Response		0.5	0.6	VDC
T _{rec}	Recovery Time		1	5	ms
t _{v1 rise}	Output Voltage Rise Time		2	20	ms
t _{v1 on}	Output turn-on time			2	s
C _{V1 load}	Capacitive Loading	0		66	mF
Auxiliary Output V_{AUX} (54 V)					
V _{AUX nom}	Output Voltage		54		VDC
dV _{AUX tot}	Total Static Regulation	-1		+1	%V _{BC}
P _{AUX nom}	Output Power		300		W
I _{AUX nom}	Output Current	0		5.7	A
dV _{AUX load}	Load Regulation		1.9		V
dV _{AUX line ac}	AC Line Regulation	-50	0	50	mV
dV _{AUX line dc}	DC Line Regulation	-50	0	50	mV
dV _{AUX lt}	Load Transient Response			1.35	VDC
t _{rec}	Recovery Time		50		ms
t _{vAUX rise}	Output Voltage Rise Time		70	100	ms
	Output turn-on		260		ms
C _{vAUX load}	Capacitive Loading	0		3.3	mF
Battery Charger Output V_{BC} (52.5 V)					
V _{BC nom}	Output Voltage		52.5		VCD
dV _{BC tot}	Total Static Regulation	-0.5		+0.5	%V _{BC}
P _{BC nom}	Output Power		270		W
	Output Current	0		5	A
dV _{BC load}	Load Regulation	170	220	282	mV
dV _{BC line}	AC Line Regulation	-40	0	40	mV
t _{vBC rise}	Output Voltage Rise Time		80	150	ms

V2 Power Module & V2 Power Shelf

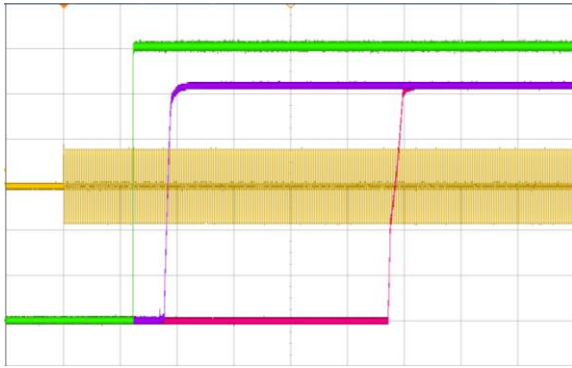

Figure 8. Turn-On AC Line 277VAC, full load (500ms/div)
 CH1: V_{in} (500V/div) CH2: V_1 (2V/div) CH3: V_{AUX} (10V/div)
 CH4: V_{BC} (10V/div)

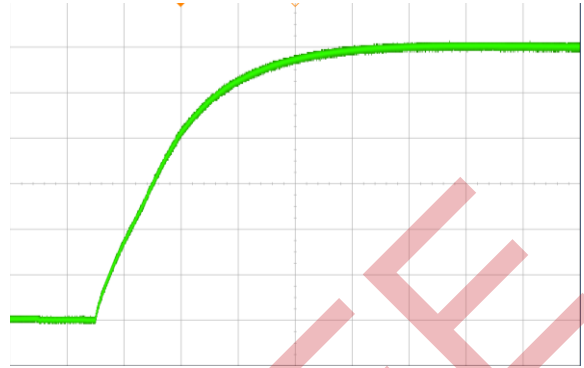

Figure 9. Rise time V_1 at 277VAC, full load (500 μ s/div)
 CH1: V_{AUX} (10V/div) CH2: V_1 (2V/div)

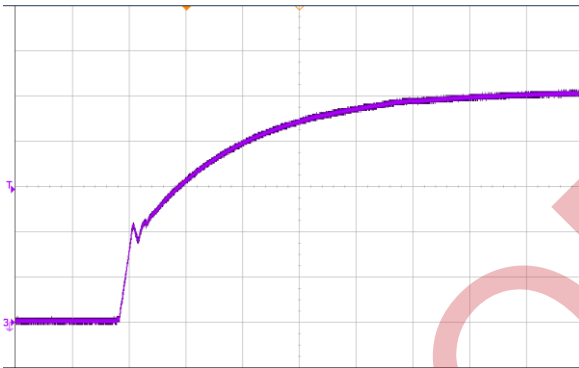

Figure 10. Rise time V_{AUX} at 277VAC, full load (20ms/div)
 CH1: V_1 (2V/div) CH3: V_{AUX} (10V/div)

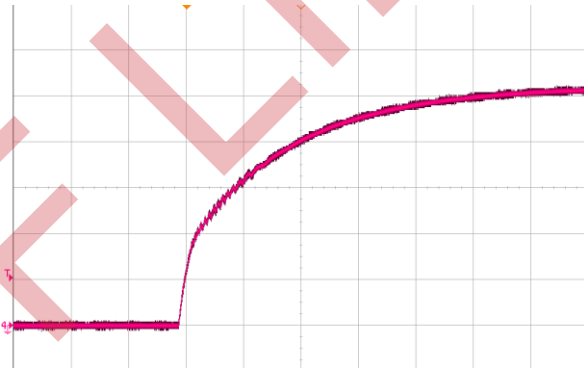

Figure 11. Rise time V_{BC} at 277VAC, 2A load (50ms/div)
 CH1: V_{AUX} (10V/div) CH4: V_{BC} (10V/div)

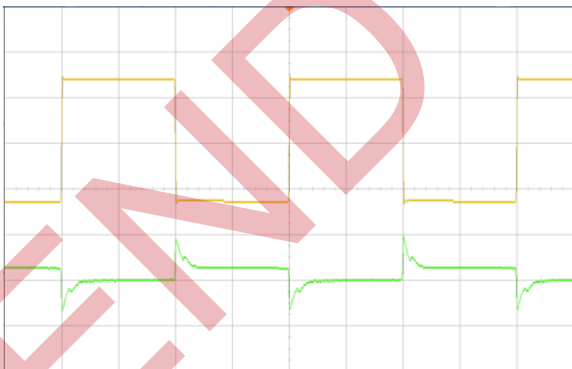

Figure 12. Load transient V_1 , 133A to 265A, 1A/ μ s (5ms/div)
 CH1: I_1 (50A/div) CH2: V_1 (500mV/div)

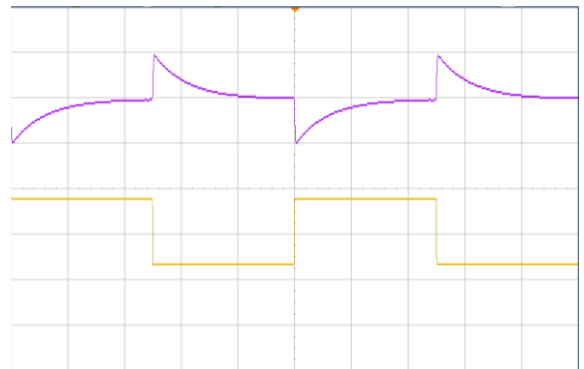

Figure 13. Load transient V_{AUX} , 2.8A to 5.7A (100ms/div)
 CH1: I_{AUX} (2A/div) CH2: V_{AUX} (1V/div)

3.3.1 OUTPUT ISOLATION

Main, auxiliary and battery charger output and all signals are isolated from the chassis and protective earth connection. However, the applied voltage between any of these voltages and chassis must not exceed 100 V_{peak} to prevent any damage to the supply.

The RS485 communication lines and shelf/rack addresses (RS485_D / RS485_DN / ADD3...5) are additionally isolated from all others.

Internal to the module the main output ground (GR1, also connected directly to FAN_SUPPLY_R in the module), the auxiliary ground (AUX_54V_R) and the battery charger ground (BAT_R) are interconnected through 10 Ω resistors to prevent any circulating current within the supply. The signal ground (GR5) is connected with 0.33 Ω to the main output ground.

3.4 BACKUP AND BATTERY CHARGE BEHAVIOR

Each of the power modules is separately connected to its Battery Backup unit (BBU). The BBU and PSU are designed to support maximum 90 s of full load back-up time in case of an outage.

The battery is being re-charged by the 270 W (5 A /52.5 V) battery charger circuit in the PSU.

The BBU has 8 digital lines to the PSU with which it flags errors and requests operations (see also section 3.7).

Additionally, there is also an I2C communication between the PSU and the BBU which is implemented to allow the user to access some of the battery registers via the RS485 interface.

3.4.1 BACKUP BEHAVIOR

If the AC input voltage is falling below V_{iac off} or if the frequency is outside the valid operating range f_i, the PSU is changing to DC operation and taking the power from the BBU.

The power module implements a soft startup when transitioning to battery backup mode, limiting the current overshoot as the bulk voltage is ramped back to a nominal level. No deviation occurs on the main output voltage.

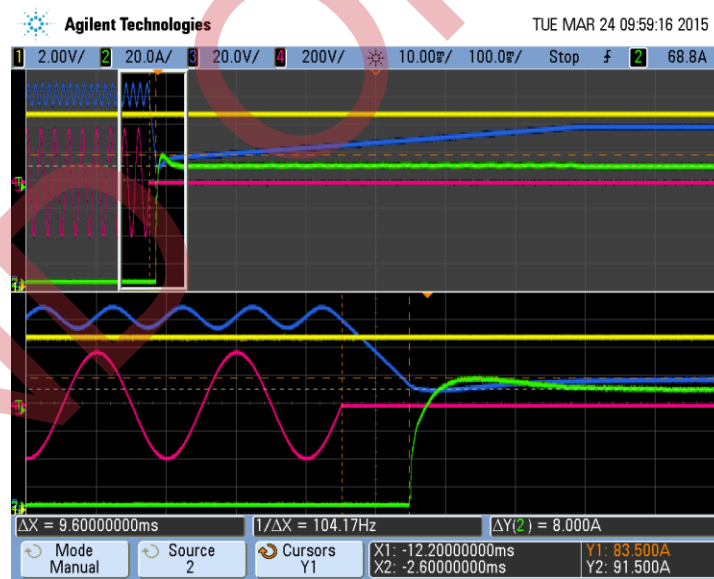

Figure 14. Backup Transition CH1: V_i (2V/div) CH2: I_{batt} (20A/div) Ch3: V_{BULK} (20V/div) Ch4: V_{Ac}(200V/div)

After 45 s in DC operation the PWR_FAIL signal is set. After 90 s without AC return the PSU is shutting down and only is restarting with a valid AC voltage restored.

V2 Power Module & V2 Power Shelf

If a valid AC voltage is re-applied after less than 90 s, the shelf is transitioning back to AC operation without any deviation at the output. The time between AC voltage present and the transition from DC to AC operation is random from one shelf to the other to reduce the stress on the AC supply.

3.4.2 BATTERY CHARGER BEHAVIOR

The BBU decides on its own if it needs to be re-charged. Charging is requested by setting the BAT_CRG_EN flag. The PSU reacts on this flag by starting the 52.5 V battery charger with a controlled current ramp up. If the battery charger is running for more than 5 consecutive hours it is shut down and a failure is flagged.

3.4.3 BBU STATE OF HEALTH CHECK

The BBU will determine internally with a random logic if it needs to be tested, and requests with the BAT_SOH_CHK signal a test discharge.

The power modules in the shelf decide based on their own and the other modules state, if they can do such a discharge. A state of health test discharge is only done if:

- All 3 PSUs and BBUs are installed and communication is available
- No other BBUs self-check is ongoing
- No PSUs or BBUs failed
- No BBU being charged at the moment
- All PSUs in AC operation
- PSU load is >500 W for at least 1 consecutive minute

The BBU will determine if the test was valid and decide if it has reached the end of life and set the BAT_EOL signal if required.



3.5 PROTECTION

There are various protection features implemented in the unit, which will help to protect the unit, BBU and system and flag the failure. The bit position of the flagged error through the RS485 communication can be found in the communication manual BCA.00072 and is referenced here as "StatusBitName". "FlagName".

	RS485 FLAG	PROTECTION	PARAMETER / DESCRIPTION	MIN	NOM	MAX	UNIT
AC Input							
F	PFC.AC_FUSE_FAIL	Input fuse (L)	Not user accessible, fast		25		A
$V_{iac\ off}$			AC UV Threshold		See 3.2		
$V_{iac\ on}$	PFC.UVP_ERROR	AC Input Under Voltage Protection	AC UV Reset Threshold		See 3.2		
$t_{vac\ UV\ SW}$					5		ms
DC Input							
$V_{idc\ OV\ SW}$	CF.BATT_OVP_ERROR	Over Voltage V_{BAT} Protection			56		VDC
$V_{idc\ UV\ SW}$			Software UV Threshold		31.85		VDC
$V_{idc\ UV\ HW}$	CF.BATT_UVP_ERROR	Under Voltage V_{BAT} Protection	Hardware UV Threshold		28		VDC
BBU							
	BBU.BATTERY_PROTECTION		See BBU datasheet				
	BBU.BATTERY_SLEEP		See BBU datasheet				
	BBU.BATTERY_STOP_DCRG		See BBU datasheet				
	BBU.BATTERY_END_OF_LIFE		See BBU datasheet				
	BBU.BATTERY_FAILURE		See BBU datasheet				
Main Output V1 (12.6 V)							
$V_1\ OV\ HW$		Fast Over Voltage V_1 Protection, Latch-Off Type	Fast OV Threshold V_1	14.2	14.6	15.3	VDC
$t_{V1\ OV\ HW}$	LLC.OVP_HW_ERROR		Time from OV applied to Latch-Off			1	ms
$I_{V1\ CL\ REG}$	No Flag	Regulation Current Limitation, Constant-Current Type	Maximum regulated current		286		ADC
$I_{V1\ OC\ SW}$		Over Current Limitation, Latch-Off Type	Slow OC Limit V_1	274	280	294	ADC
$t_{V1\ OC\ SW\ latch}$	MISC.12V_OCP_ERROR		Time from OC detected to Latch-Off		2		s
$I_{V1\ OC\ HW}$		Fast Over Current Limitation, Shut-down Type	Fast OC Limit		350		ADC
$t_{V1\ OC\ HW\ restart}$	No Flag		Time from OC detected to Restart	4			ms
$V_1\ UV$		Under Voltage V_1 Protection, Latch-Off Type	UV Threshold V_1		10		V
$t_{V1\ UV\ trip}$	MISC.12V_UVP_ERROR		Time from UV applied to Latch-Off		2		s
	LLC.ARCING_ERROR	Arcing protection	Repeated short overload on the main output				
	LLC:HOLD_UP_ERROR	Hold-up error	If $V_1 < 8V$ and frequency below min. level		10		ms
	LLC.DCDC_ERROR	General V1 converter error					
Auxiliary Output VAUX (54 V)							
$V_{AUX\ OV\ SW}$		Slow Over Voltage V_{AUX} Protection, Latch-Off Type	Slow OV Threshold V_{AUX}		56		VDC
$t_{VAUX\ OV\ SW}$	AUX.SW_OVP_ERROR		Time from OV applied to Latch-Off		5		ms
$V_{AUX\ OV\ HW}$		Fast Over Voltage V_{AUX} Protection, Latch-Off Type	Fast OV Threshold V_{AUX}	58.5	59	59.5	VDC
$t_{VAUX\ OV\ HW}$	AUX.HW_OVP_ERROR		Time from OV applied to Latch-Off			1	ms
$I_{VAUX\ CL\ REG}$	No Flag	Current regulation max V_{AUX}	Regulation Current Limitation, Constant-Current Type		6.4		ADC
$V_{AUX\ UV}$			UV Threshold V_{AUX}		40		V
$t_{VAUX\ UV\ trip}$		Under Voltage V_{AUX} Protection, Latch-Off Type	Time from Under Voltage applied to Shut-down		10		ms
$t_{VAUX\ UV\ restart}$	AUX_SW_UVP_ERROR		Time from Under Voltage applied to Restart		3		s
$t_{VAUX\ UV\ latch}$			Time from Restart to Latch-Off		2		s

Battery Charger Output V _{BC} (52.5 V)						
V _{BC} OV SW	BC.SW_OVP_ERROR	Slow Over Voltage V _{BC} Protection, Latch-Off Type	Slow OV Threshold V _{BC}	54		VDC
t _{VBC} OV SW			Time from OV applied to Latch-Off	5		ms
V _{BC} OV HW	BC.HW_OVP_ERROR	Fast Over Voltage V _{BC} Protection, Latch-Off Type	Fast OV Threshold V _{BC}	56.5	57	57.5 VDC
t _{VBC} OV HW			Time from OV applied to Latch-Off		1	ms
I _{VBC} CL REG	No Flag	Current regulation max V _{BC}	Regulation Current Limitation, Constant-Current Type		5	ADC
V _{BC} UV			UV Threshold V _{BC}		13	V
t _{VBC} UV trip	BC.SW_UVP_ERROR	Under Voltage V _{BC} Protection, Shut-down Type	Time from UV applied to Shut-down		10	ms
t _{VBC} UV restart			Time from UV applied to Restart		4.2	s
V _{BC} out of reg		Out of regulation V _{BC} If I _{BC} < 300mA and outside these limits, Latch-Off Type	Regulation Limits	51.45		53.55 V
t _{VBC} out of reg	BC.V_OUT_ERROR		Time from out of regulation detected to Latch-Off		2	s
t _{VBC} timeout	BC.TIMEOUT_ERROR	Timeout error, Latch-Off Type	Time from Battery Charger started to Latch-Off		5	h
Other Protections						
	TEMP.***_ERROR	OTP, Latch-Off Type	Over Temperature protection: See also section 3.8.2			
	FAN.RPM_ERROR	Fan Error, Latch-Off Type	Fan speed error: see also section 3.8.2			
	COM.F*_FW_ERROR	FW Error	Wrong / mismatching Firmware programmed on PSU			
	COM.F*_COM_ERROR	Communication error	F1-F3 fatal internal communication error			
	COM.CAN_COM_ERROR	Communication error	CAN communication problem in the shelf			

3.5.1 LATCH-OFF AND CLEARING

If an error on the main 12.6 V output occurs which is latching off this converter, it will also shut down and latch the auxiliary and battery charger converter.

If the auxiliary or the battery charger converter fail with a latching error, they will not shut down any of the other converters.

The latching faults can be cleared/unlocked by disconnecting the supply from the AC mains for >2 s with a shutdown of the main output (not going into backup mode), or by toggling the PS_KILL input.

3.5.2 INPUT FUSE

Fast-acting 25 A input fuse (6.3 x 32 mm) in series with the L-line inside the power supply protects against severe defects. The fuse is not accessible from the outside and is therefore not a serviceable part.

3.5.3 AC INPUT UNDER-VOLTAGE

If the sinusoidal input voltage stays below the input undervoltage lockout threshold $V_{i on}$ or falls below $V_{i off}$ during operation, the supply will be inhibited. Once the input voltage returns within the normal operating range, the supply will return to normal operation again.

If a good battery back-up unit is present, the unit can keep on operating for up to 90 s in case of AC outage. More details see in Section 3.4.

3.5.4 DC INPUT UNDER-VOLTAGE

There are several protection levels for the DC input under voltage. The BBU module will begin to protect itself at 33.8 V. Below this level, the PSU will protect at the Software under voltage threshold of 31.85 V, and this undervoltage is ignored during the first 15 seconds of backup to account for temporary dips during current ramp up. Finally, below this level is the hardware under voltage at 28 V.

3.5.5 OVERVOLTAGE PROTECTION

The SPAFCBK-11G front-end provides a fixed threshold overvoltage (OV) protection implemented with a HW comparator for the main, the auxiliary and the battery charger output. Once an OV condition has been triggered, the supply will shut down the converter. The auxiliary and battery charger output have in addition to the HW overvoltage protection a software overvoltage detection implemented.

3.5.6 UNDERVOLTAGE DETECTION

All three outputs have a software under voltage protection implemented. If the main output voltage falls below the under voltage level $V_{1\text{ UV}}$ for a time $> t_{V1\text{ UV trip}}$ it will latch-off. If the auxiliary output falls below the under voltage limit $V_{\text{AUX UV}}$ for a time $> t_{\text{VAUX UV trip}}$ the control circuit will attempt to restart the converter, if voltage is not restored before $t_{\text{VAUX UV latch}}$ the output will latch-off. If the battery charger falls below the under voltage limit $V_{\text{BC UV}}$ for a time $> t_{\text{VBC UV trip}}$ the control circuit will attempt to restart the converter, and remain on indefinitely.

3.5.7 OUT OF REGULATION DETECTION BATTERY CHARGER

If the battery charger current is less than 300 mA (which indicates the battery is nearly charged), the voltage is monitored to stay inside the regulation bandwidth. If the voltage is outside this band for more than $t_{\text{VBC out of reg}}$ the control circuit will shut down the battery charger output and latch off.

3.5.8 CURRENT LIMITATION

Main Output

The main output exhibits a substantially rectangular output characteristic controlled by a software feedback loop. If the output current exceeds $I_{V1\text{ CL REG}}$ it will reduce the output voltage in order to keep the output current constant. If the output current is higher than $I_{V1\text{ OC SW}}$ for more than $t_{V1\text{ OC SW latch}}$ the output will latch off. A second current limitation implemented as a fast hardware detection circuit will immediately switch off the main output if the output current increases beyond the peak current trip point, occurring mainly if a short circuit is applied to the output voltage. The supply will re-start after $t_{V1\text{ OC HW restart}}$ with a soft start.

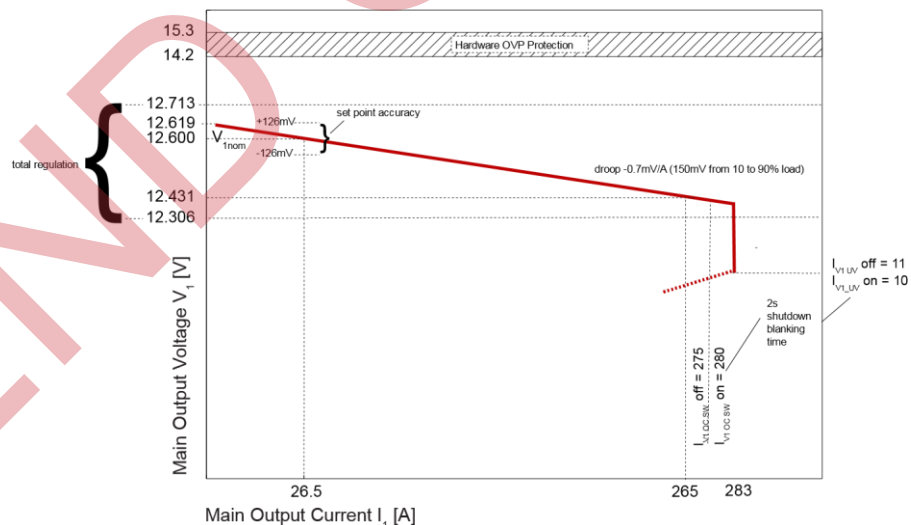

Figure 15. Current Limitation on V_1

Auxiliary Output

The auxiliary output exhibits a substantially rectangular output characteristic, controlled by a hardware feedback loop. If the output current exceeds $I_{VAUX_CL_REG}$ it will reduce the output voltage in order to keep the output current constant.

Running in current limitation causes the output voltage to fall, this will trigger the under voltage protection, see also [Undervoltage Detection](#).

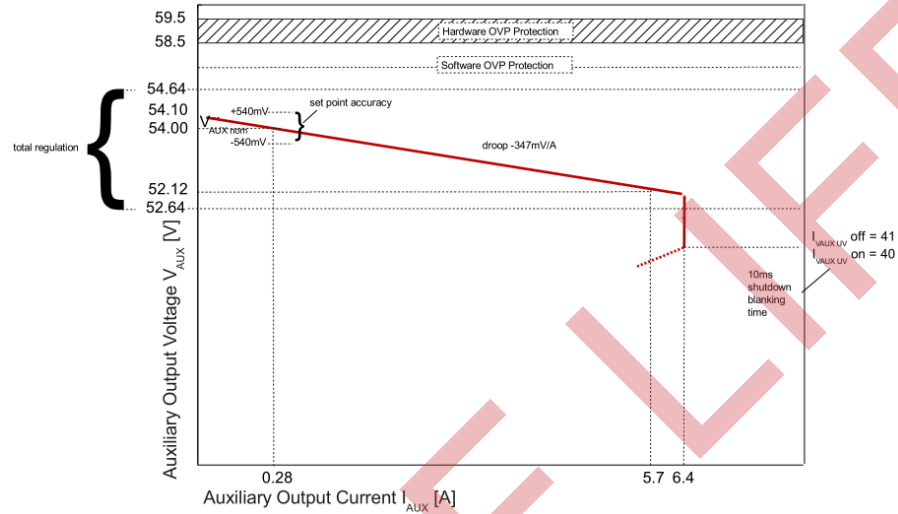

Figure 16. Current Limitation on Vaux

Battery Charger Output

The battery charger output exhibits a substantially rectangular output characteristic, controlled by a hardware feedback loop. If the output current exceeds $I_{VBC_CL_REG}$ it will reduce the output voltage in order to keep the output current constant.

Running in current limitation causes the output voltage to fall, this will trigger the under voltage protection, see also [Undervoltage Detection](#).

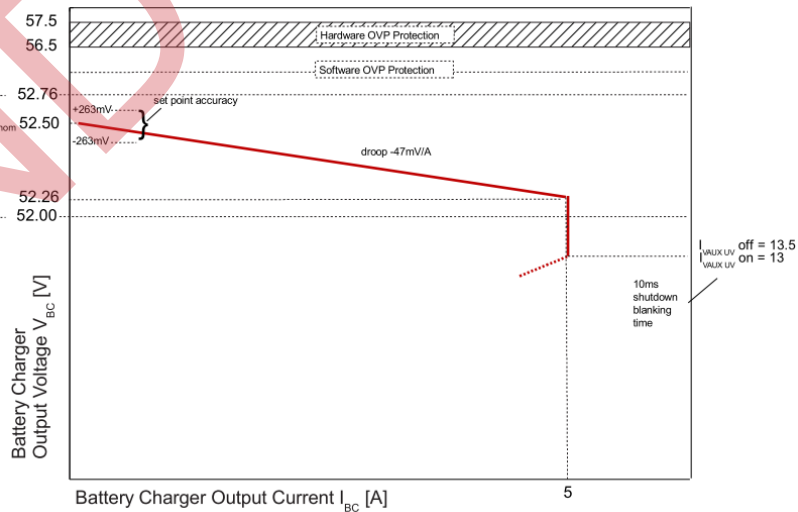

Figure 17. Current Limitation on Vbc

3.6 MONITORING

The power supply operating parameters can be accessed through the RS485 interface. For more details refer to document BCA.00072 (SPAFCBK-11G RS485 Communication Manual)

PARAMETER	DESCRIPTION / CONDITION	MIN	NOM	MAX	UNIT
V _{iac mon}	AC Input RMS Voltage V _{iac} MIN ≤ V _{iac} ≤ V _{iac} MAX	-2		+2	VAC
I _{iac mon}	AC Input RMS Current I _{iac} > 5 Arms	-5		+5	%
	I _{iac} ≤ 5 Arms	-0.25		+0.25	Arms
P _{iac mon}	AC True Input Power P _{iac} > 900 W	-5		+5	%
	P _{iac} < 900 W	-45		+45	W
V _{idc mon}	DC Input Voltage V _{idc} MIN ≤ V _{idc} ≤ V _{idc} MAX	-2		+2	VAC
V _{bat mon}	Battery Sense Voltage V _{idc} MIN ≤ V _{bat} ≤ V _{idc} MAX	-0.5		+0.5	%
I _{idc mon}	DC Input Current I _{idc} > 40A	-8		+8	%
	I _{idc} ≤ 40A	-3.2		+3.2	Arms
V _{1 mon}	V ₁ Voltage V ₁ MIN ≤ V ₁ ≤ V ₁ MAX	-1		+1	%
I _{1 mon}	V ₁ Current	-2.65		+2.65	ADC
V _{AUX mon}	V _{AUX} Voltage V _{AUX} MIN ≤ V _{AUX} ≤ V _{AUX} MAX	-1		+1	%
I _{AUX mon}	V _{AUX} Current I _{AUX} > 2 A	-6		+6	%
	I _{AUX} ≤ 2 A	-0.12		+0.12	A
V _{BC mon}	V _{BC} Voltage I _{BC mon} ≤ 1A ¹	-0.5		+0.5	%
I _{BC mon}	I _{BC} Current I _{BC} > 2 A	-5		+5	%
	I _{BC} ≤ 2 A	-0.1		+0.1	A
P _{o mon}	Total Output Power P _i > 900 W	-3		+3	%
	P _i < 900 W	-27		+27	W
T _{input mon}	Inlet Temperature AC operation, T _A MIN ≤ T _A ≤ T _A MAX	-5		+7	°C

¹ The voltage measurement is before the Or-ing and does therefore not include the passive droop on the Or-ing and the PCB. Therefore, the readback is valid for the external voltage only valid for low current.

3.7 SIGNALLING AND CONTROL

3.7.1 OVERVIEW

PARAMETER	DESCRIPTION / CONDITION	CRITERION
<i>Input Signals from Shelf</i>		
PS_KILL	To flag the PSU if it is inserted in the shelf Recessed pin (last make / first break)	Pulled to the ground inside the Shelf
ADD1...2	Address pins for RS485 PSU address for the location of the PSU in the shelf;	Hard wired in the shelf. See also section SIGNALLING AND CONTROL 5.4 and 3.8.1 and Communication Manual BCA.00072
ADD3...5	Address pins for RS485 PSU address for the location of the shelf inside the rack; Referred to RS485 isolated ground	Set by the user via a shelf input connector. See also section 5.4 and communication manual BCA.00072
<i>Input Signals from BBU</i>		
BAT_FAIL	Signal flagging a BBU failure	
BAT_STOP_DCRG	Signal commanding to stop discharging the Battery	
BAT_SLEEP	Signal flagging missing 12 V in the BBU	
BAT_EOL	Battery End of Life signal	
BAT_PROT	Battery protection signal to HW shut down current feed circuit	
BAT_SOH_CHK	Battery requesting state of health check	
BAT_CRG_EN	Battery charger enable signal	
BAT_KILL	To flag the PSU if a BBU is present in the shelf Recessed pin (last make / first break)	Pulled to the ground inside the BBU
BAT_VSENSE / BAT_VSENSE_R	Battery voltage sense signals	
<i>Output Signals to Shelf</i>		
PWR_FAIL	Signal to flag potential loss of power due to backup timeout; Active low, normally high open collector signal	This signal is pulled low if the PSU is 45 s in backup and AC is not yet returned See also section 3.4
RED_LOST	Signal to flag loss of redundancy; Active low, normally high open collector signal	This signal is pulled low if at least one PSU or BBU in the shelf has failed, is not operational or is not present. The signal is not pulled low in case of a BAT_PROT or BAT_STOP_DCRG event. See also section 5.4.
<i>Bidirectional Signals to Shelf</i>		
SYNC1-3	Reserved to synchronize PSU turn-on, turn-off and transition	See also section 5.4.
ISHARE	Current share line	See also section 5.4.
RS485_D / RS485_DN	RS485 communication lines for monitoring of all PSUs; Isolated from other outputs	See also 3.8.1.
CAN_H / CAN_L	CAN communication lines for inter- PSU communication in the shelf	
<i>Output Signals to BBU</i>		
BAT_NSRT	To flag the BBU if a PSU is present in the shelf Recessed pin (last make / first break)	Pulled to the signal ground inside the PSU
<i>Bidirectional Signals to Shelf</i>		
BAT_I2C_SDA/ BAT_I2C_SCL	I2C communication to the BBU	

3.7.2 ELECTRICAL CHARACTERISTICS

PARAMETER	DESCRIPTION / CONDITION	MIN	NOM	MAX	UNIT
PS_KILL / BAT_KILL input					
V _{IL}	Input Low Level Voltage	PSU / BBU is inserted	-0.2	0.8	V
V _{IH}	Input High Level Voltage	PSU / BBU is removed	2.2	3.5	V
I _{IL,H}	Maximum Input Sink or Source Current	V _I = -0.2 V to +3.5 V	-1	1	mA
R _{pull up}	Internal Pull up Resistor to internal 3.3 V		10		kΩ
R _{LOW}	Maximum external Pull down Resistance to GND to obtain Low Level			1	kΩ
R _{HIGH}	Minimum external Pull down Resistance to GND to obtain High Level	50			kΩ
ADD1...5 inputs					
V _{IL}	Input Low Level Voltage		-0.2	0.8	V
V _{IH}	Input High Level Voltage		2.2	3.5	V
I _{IL,H}	Maximum Input Sink or Source Current	V _I = -0.2 V to +3.5 V	-1	1	mA
R _{pull up}	Internal Pull up Resistor to internal 3.3V		10		kΩ
R _{LOW}	Maximum external Pull down Resistance to GND to obtain Low Level			1	kΩ
R _{HIGH}	Minimum external Pull down Resistance to GND to obtain High Level	50			kΩ
BAT_FAIL / BAT_STOP_DCRG / BAT_SLEEP / BAT_EOL / BAT_PROT / BAT_SOH_CHK / BAT_CRG_EN inputs					
V _{IL}	Input Low Level Voltage		-0.2	0.8	V
V _{IH}	Input High Level Voltage		2.2	3.5	V
I _{IL,H}	Maximum Input Sink or Source Current	V _I = -0.2 V to +3.5 V	-1	1	mA
R _{pull up}	Internal Pull up Resistor to internal 3.3 V		10		kΩ
R _{LOW}	Maximum external Pull down Resistance to GND to obtain Low Level			1	kΩ
R _{HIGH}	Minimum external Pull down Resistance to GND to obtain High Level	50			kΩ
PWR_FAIL / RED_LOST outputs					
V _{OL}	Output Low Level Voltage	I _{sink} < 4 mA	-0.2	0.4	V
V _{pull up}	External pull-up voltage			20	V
R _{pull up}	Recommended external pullup resistor at V _{pull up} = 12 V		10		kΩ
I _{OL}	Maximum Sink Current	V _O < 0.4 V		4	mA

Table 1. Signal Electrical Characteristics

3.7.3 INPUT / OUTPUT SIGNAL PROTECTION

All digital input signals (all but BAT_VSENSE(_R)) have inside the PSU protection diodes added which limit the voltage to the ground on the lower side and to the internal 3.3 V on the higher side. The PWR_FAIL and RED_LOST output signals have inside the PSU 15 V Zener diodes added versus ground.

3.7.4 BATTERY VOLTAGE SENSE INPUTS BAT_VSENSE(_R)

The BBU provide sense lines to more accurate monitor the battery voltage excluding the voltage drop on load wires in both positive and negative path.

3.7.5 CURRENT SHARE ISHARE

The SPAFCBK-11G front-end has an active current share scheme implemented for V1. All the ISHARE current share pins need to be interconnected in order to activate the sharing function. If a supply has an internal fault or is not turned on, it will disconnect its ISHARE pin from the share bus. This will prevent dragging the output down (or up) in such cases.

The current share function uses a digital bi-directional data exchange on a recessive bus configuration to transmit and receive current share information. The controller implements a Master/Slave current share function. The power supply providing the largest current among the group is automatically the Master. The other supplies will operate as Slaves and increase their output current to a value close to the Master by slightly increasing their output voltage. The voltage increase is limited to +250 mV.

The Auxiliary output uses a passive current share method (droop output voltage characteristic).

3.7.6 PS_KILL INPUT

PSKILL input is an active-low recessed pin in the connector and is used to shut down the circuits as soon as the power supply is being pulled out. This pin is connected to ground in the power shelf.

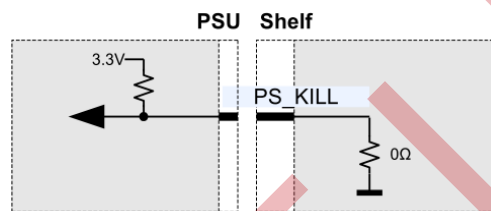

Figure 18. PS_KILL connection

3.7.7 BAT_KILL INPUT

PSKILL input is an active-low recessed pin in the connector and is used to shut down the circuits as soon as the power supply is being pulled out. This pin is connected to ground in the power shelf.

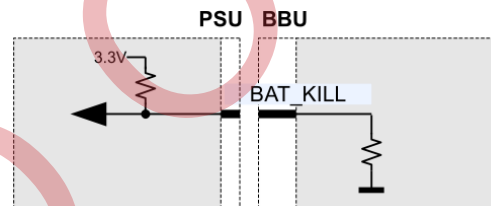

Figure 19. BAT_KILL connection

3.7.8 BAT_NSRT OUTPUT

The BAT_NSRT output is wired inside the PSU to ground. This is a recessed pin and does indicate that there is a power supply present.

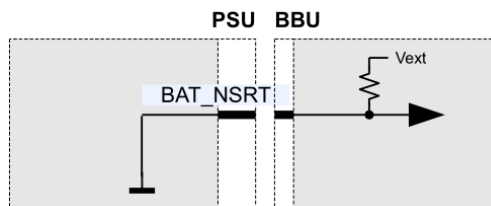

Figure 20. BAT_NSRT connection

3.7.9 PWR_FAIL OUTPUT

The PWR_FAIL signal indicates that the power supply is in risk of losing the output power in backup mode. It is pulled low after 45s in backup operation if AC is not returned. It is an open collector signal which needs to be pulled up to an external voltage. (See limits in *Table 1*.)

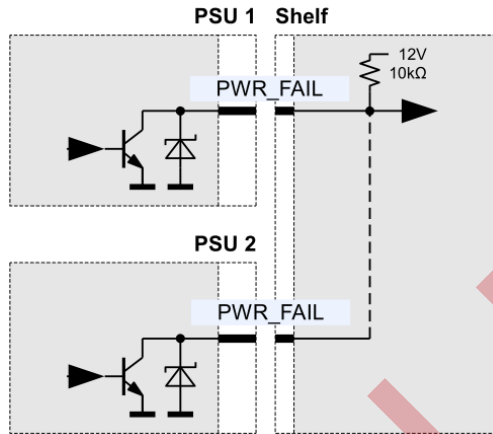

Figure 21. PWR_FAIL connection

3.7.10 RED_LOST OUTPUT

The RED_LOST signal indicates that the shelf is not operating in redundancy anymore. It is pulled low if at least one PSU or BBU in the shelf is failed, not operational or not present. The signal is not pulled low in case of a BAT_PROT or BAT_STOP_DCRG event. It is an open collector signal which needs to be pulled up to an external voltage. (See limits in *Table 1*.)

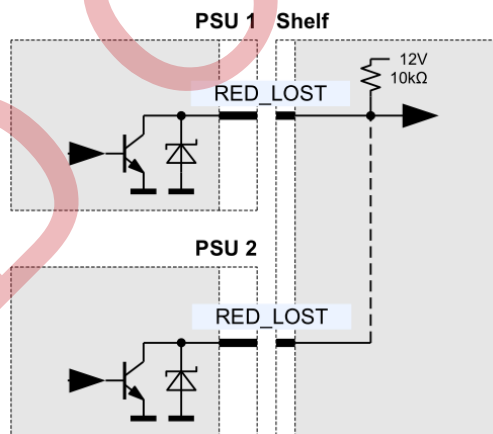
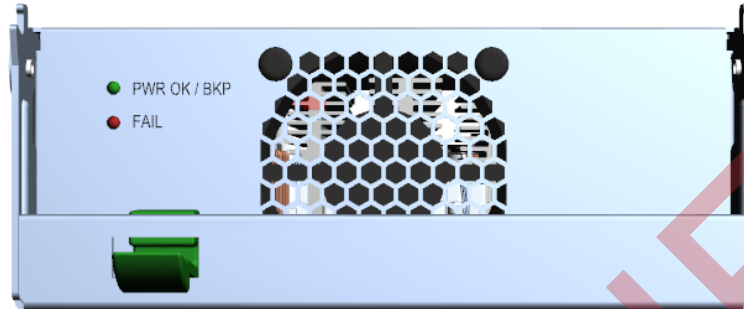

Figure 22. RED_LOST connection

V2 Power Module & V2 Power Shelf

3.7.11 LED INDICATOR

The power module has two front LEDs showing the status of the supply. The LED PWR OK / BKP LED is bi-colored: green and amber, and indicates AC and DC power presence. The red FAIL LED indicates warning or fault conditions. **Table 2** lists the different LED status.



LED	LED STATUS	CONDITION
PWR OK LED / BKP LED	Off	Unit is off or 12.6 VDC output is out of regulation.
	Amber solid	When a valid AC input is applied, 12.6 VDC output is in regulation, and BBU is not installed or not ready for use. OFF otherwise
	Green solid	When a valid AC input is applied, 12.6Vdc output is in regulation, and a BBU is installed and ready for use. OFF otherwise
	Amber/Off blinking	During backup phase (90 second timeout).
	Green/Off blinking	FW upgrade in progress
FAIL	Off	General power module failure (FAN failure is included. OFF otherwise If the 54Vdc auxiliary or the BBU step-up or step-down battery charger converter fails, the Red LED will turn on and the Fail signal will be latched but the main converter (LLC) will still provide 12.6Vdc to the busbars.
	Red solid	General power supply failure <ul style="list-style-type: none"> • The output 12V before the OR-ing MOS goes out of regulation • Fan failure or fan low speeds (5 sec delay on persistency) • Over current protection (2 sec delay on persistency) • Over temperature protection (2 sec delay on persistency) • Over voltage protection • AC fuse failure (5 to 30 sec delay)

Table 2. LED Status Indication

3.8 COMMUNICATION

3.8.1 RS485 / MODBUS COMMUNICATION

The SPAFCBK-11G front-end is a communication slave device only; it never initiates messages on the RS485/MODBUS by itself. Communication to the MCU will be possible as long as the input AC voltage is provided and above $V_{on\ bias}$. For more information about the communication, see Communication Manual BCA.00072.

3.8.2 TEMPERATURE AND FAN CONTROL

To achieve best cooling results sufficient airflow through the supply must be ensured. Do not block or obstruct the airflow at the rear of the supply by placing large objects directly at the output connector. The SPAFCBK-11G is provided with a front to rear airflow, which means the air enters through the front panel of the supply and leaves at the connector side. The SPAFCBK-11G supply has been designed for horizontal operation. The fan inside of the supply is controlled by a microprocessor. The RPM of the fan is adjusted to ensure optimal supply cooling and is a function of the inlet, outlet and critical component temperatures. There is no direct dependency on the delivered power.

The SPAFCBK-11G provides access via RS485 to the measured temperatures of in total 8 sensors within the power supply, see **Table 3**. The microprocessor is monitoring these temperatures and increases the fan speed based on those. If a critical level is reached, the temperature warning bit is set. If temperatures continue to rise above the shut down threshold all outputs will be disabled. At the same time the warning or fault condition is signaled accordingly by a LED (see LED signaling in **Table 2**).

TEMPERATURE SENSOR	DESCRIPTION / CONDITION	RESTART THRESHOLD	WARNING THRESHOLD	SHUT DOWN THRESHOLD
Inlet air temperature	Sensor located on main board close to front panel of power supply	50 °C	55 °C	60 °C
Outlet air temperature	Sensor located on main board close to connector end of the power supply	100 °C	105 °C	110 °C
PFC heat sink	Sensor located close to the PFC heat sink	100 °C	105 °C	110 °C
V_1 primary heat sink	Sensor located close to one of the V_1 primary heat sinks	95 °C	100 °C	105 °C
V_1 synchronous rectifier	Sensor located close to V_1 synchronous rectifier devices	110 °C	115 °C	120 °C
V_1 OR-ing elements	Sensor located close to V_1 OR-ing devices	110 °C	115 °C	120 °C
V_{bc} secondary heat sink	Sensor located close to V_{bc} secondary heat sink	95 °C	100 °C	105 °C
Current feed heat sink	Sensor located close to current feed heat sink	110 °C	115 °C	120 °C

Table 3. Temperature sensor location and thresholds

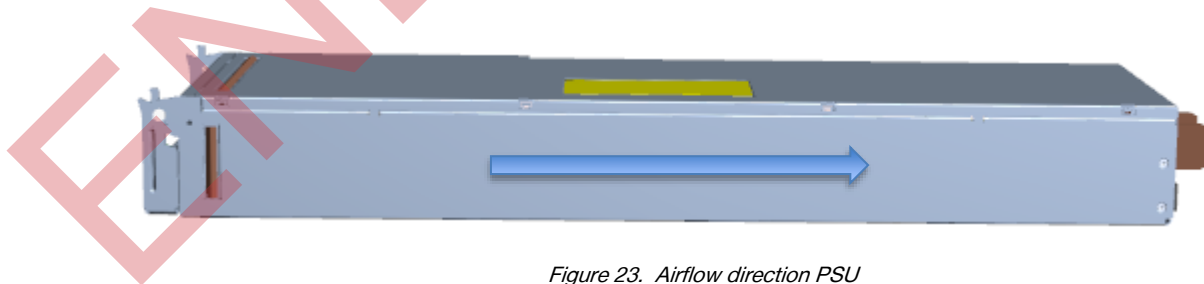

Figure 23. Airflow direction PSU

3.9 ELECTROMAGNETIC COMPATIBILITY

3.9.1 IMMUNITY

PARAMETER	DESCRIPTION / CONDITION	CRITERION
ESD Contact Discharge	IEC / EN 61000-4-2, ±8 kV	A
ESD Air Discharge	IEC / EN 61000-4-2, ±15 kV	A
EFT / Burst	IEC / EN 61000-4-4, Level 4	A
Surge	IEC / EN 61000-4-5 Differential Mode 2 kV (Line to Neutral) Common Mode 4 kV (Line/Neutral to Earth)	A

3.9.2 EMISSION

PARAMETER	DESCRIPTION / CONDITION	CRITERION
Conducted Emission	FCC Part 15 / EN 55022/ CISPR 22	Class B
Radiated Emission	FCC Part 15 / EN 55022/ CISPR 22	Class B
Harmonic Current Emissions	IEC 61000-3-2 Vi = 277 VAC / 60 Hz & 230 VAC / 50Hz, 100% load	Class A

3.10 SAFETY / APPROVALS

Maximum electric strength testing is performed in the factory according to IEC/EN 60950 and UL 60950. Input-to-output electric strength tests should not be repeated in the field. Bel Power Solutions will not honor any warranty claims resulting from electric strength field tests.

PARAMETER	DESCRIPTION / CONDITION	NOTE
Agency Approvals	UL 60950-1 2 nd Edition CAN/CSA-C22.2 No. 60950-1-07 2 nd Edition IEC 60950-1: 2005 EN 60950-1: 2006 cCSAus CE Mark CB Report & Certificate EU Low Voltage Directive EMC Directive UL94V-0	Approved by independent body (see CE declaration)
Insulation Strength	AC Primary to any Secondary (3000 VAC)	Reinforced
	AC Primary to Chassis GND (1500 VAC / 2121 VDC)	Basic
	Secondary to Chassis GND (100 VDC)	Functional
	RS485 Communication to AC Primary, Secondary and Chassis GND (500 VDC)	Functional
Creepage / Clearance	Primary (L/N) to chassis (PE)	According to safety standards
	AC Primary to secondary	
Production Electrical Strength Test	AC Primary ⇔ Chassis GND, Secondary and RS485	2121 VDC
	Secondary and RS485 ⇔ AC Primary and Chassis GND	100 VDC
	RS485 ⇔ AC Primary, Chassis GND and Secondary	500 VDC
	Ground Continuity Test	35 A

3.11 ENVIRONMENTAL

PARAMETER	DESCRIPTION / CONDITION	MIN	NOM	MAX	UNIT
T _A	Ambient Operating Temperature				
	Power Shelf is able to start at -15°C	-5		+45	°C
T _s	Storage Temperature				
	Non-operational	-40		+70	°C
	Transport. Temperature				
	Short term storage	-55		+85	°C
	Relative Humidity				
	Operation and storage, non-condensing	10		90	%
	Altitude				
	Operational (no derating)	-		3000	M
				10000	Ft
	Shock Operational				
	half-sine 11 ms, 5 shocks, 3 axes			6	g
	Shock Non-Operational				
	half-sine 11 ms, 10 shocks, 3 axes			12	g
	Vibration Operational				
	1.5 mm amplitude, 5 to 500 Hz, 10 sweeps at 1 octave / minute per each of the three axes			0.5	g
	Vibration Non-Operational				
	3 mm amplitude, 5 to 500 Hz, 10 sweeps at 1 octave / minute per each of the three axes			1.0	g

3.12 RELIABILITY

PARAMETER	DESCRIPTION / CONDITION	MIN	NOM	MAX	UNIT
MTBF	Mean time between failure				
	Telcordia SR 332 issue 3, GB CL =90%, T _A = 45°C, V _i = 277 VAC, 100% load without fan	500			kh

3.13 MECHANICAL

PARAMETER	DESCRIPTION / CONDITION	MIN	NOM	MAX	UNIT
Dimension	Width		165		mm
	Height		65		mm
	Depth		551.5		mm
Weight			5.5		kg

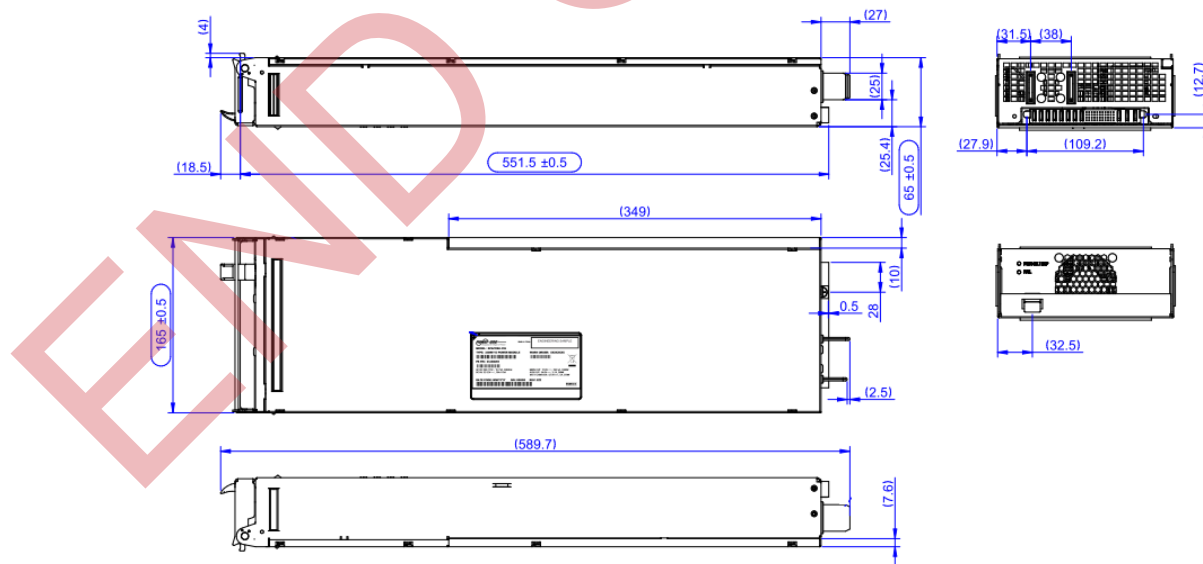
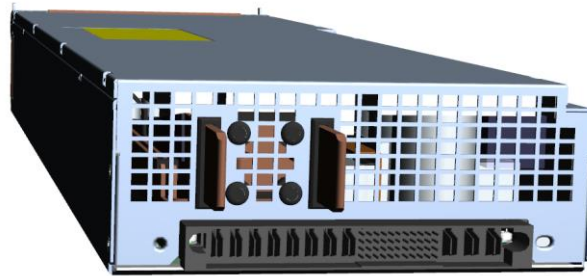

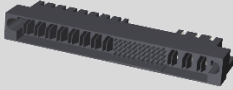

Figure 24. Mechanical Drawing

V2 Power Module & V2 Power Shelf

3.14 CONNECTORS



APPLICATION	DESCRIPTION	MANUFACTURER P/N	BEL POWER SOLUTION P/N
 V1 Output busbar	Main output busbars 3 x 25 x 34 mm	-	-
	Mating Part	Tyco 1643903-3	ZES.01258
 AC input, DC input, Auxiliary and Battery Charger output, Signals	8 Power + 44 Signals + 3Power AC pins, PwrBlade Connector, Male 90° PCB mount	FCI 51939-792LF	ZES.00478
	Mating Part	FCI 10066440-361LF (panel mount) FCI 51915-417LF (PCB mount)	

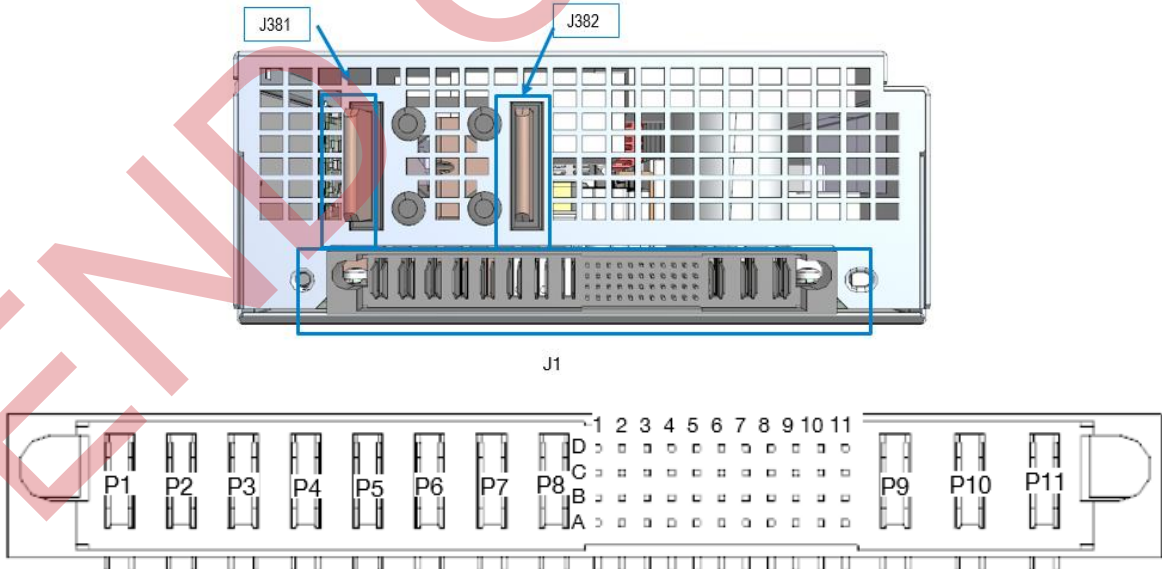

NOTE: Pins P2-P5, P10, P11, D6, C6, B6, A6 are lagging (short pins)

CONNECTOR	PIN	NAME	DESCRIPTION
<i>Power Output</i>			
J381		V1	+12 VDC main output
J382		GR1	Power ground / 12 VDC return
J1	P1	AUX_54V_R	54 VDC auxiliary output return
J1	P2	AUX_54V	+54 VDC auxiliary output
J1	D4, C4, B4, D5, C5	S_BC_52.5V	52.5 VDC battery charger
J1	D2, C2	FAN_SUPPLY_R	12 VDC supply for BBU fan return
J1	D3, C3	FAN_SUPPLY	+12 VDC supply for BBU fan
<i>Power Input</i>			
J1	P3, P4, P5	BAT	DC input from BBU
J1	P6, P7, P8	BAT_R	DC input from BBU return 52.5 VDC battery charger return
J1	P9	AC_PE	⊕ AC input protective earth
J1	P10	AC_N	AC input neutral
J1	P11	AC_L	AC input line
<i>Signals and Control</i>			
J1	D1	BAT_VSENSE	Battery voltage positive sense
J1	C1	BAT_VSENSE_R	Battery voltage negative sense
J1	B1	BAT_FAIL	Battery fail signal
J1	A1	BAT_STOP_DCRG	Battery stop discharge signal
J1	B2	BAT_SLEEP	Battery sleep signal
J1	A2	BAT_EOL	Battery end of life signal
J1	B3	BAT_PROT	Battery protection signal
J1	A3	BAT_SOH_CHK	Battery state of health check signal
J1	A4	BAT_CRG_EN	Battery charge enable signal
J1	B5, B7	GR5	Signal ground
J1	A5	BAT_KILL	Battery insertion signal
J1	D6	PS_KILL	PSU insertion signal
J1	C6	ISHARE	Current share signal
J1	B6	Reserved	
J1	A6	BAT_NSRT/ GR5	Battery insertion signal / Signal ground
J1	D7	BAT_SCL	Battery clock line for I2C communication
J1	C7	BAT_SDA	Battery data line for I2C communication
J1	A7	GR1	Power ground
J1	D8	RED_LOST	Backup redundancy status signal
J1	C8	PWR_FAIL	Power fail status signal
J1	B8	CAN_L	CAN low communication line
J1	A8	CAN_H	CAN high communication line
J1	D9	12V_SHELF	Low power 12 V for shelf control supply
J1	C9	SYNC3	Synchronization signal
J1	B9	SYNC2	Synchronization signal
J1	A9	SYNC1	Synchronization signal
J1	D10	ADD1	Address pin1
J1	C10	485_D	RS485 Data line
J1	B10	485_DN	RS485 Data N line
J1	A10	485_RTN	RS485 ground
J1	D11	ADD2	Address pin2
J1	C11	ADD3	Address pin3
J1	B11	ADD4	Address pin4
J1	A11	ADD5	Address pin5

5. V2 POWER SHELF



5.1 ABSOLUTE MAXIMUM RATINGS

Stresses in excess of the absolute maximum ratings may cause performance degradation, adversely affect long-term reliability, and cause permanent damage to the supply.

PARAMETER	DESCRIPTION / CONDITION	MIN	NOM	MAX	UNIT
$V_{i\ maxc}$	Maximum Input Voltage			305	VAC

5.2 INPUT

General Condition: $T_A = 0 \dots 45\ ^\circ\text{C}$ unless otherwise noted.

Load condition definition: 100% load corresponds to:

- (i) Main 12.6 V: 6600 W + Auxiliary 54 V: 600 W + Battery Charger 52.5 V: 270 W x 3 in AC operation
- (ii) Main 12.6 V: 6600 W + Auxiliary 54 V: 600 W in DC operation

and any fraction of it is scaling down all outputs simultaneous.

PARAMETER	DESCRIPTION / CONDITION	MIN	NOM	MAX	UNIT
AC Input					
$V_{iac\ nom}$	Nominal Input Voltage	3 Phase	277		VAC
V_{iac}	Input Voltage Range	Normal operating		305	VAC
$i_{iac\ max}$	Input Current	@ steady state, $V_{in} = 180\ \text{VAC}$, per phase	22.8		A
$i_{iac\ inrush}$	Inrush Current Limitation	@ cold start, $V_{in} = 290\ \text{VAC}$, $T_A = 35^\circ\text{C}$, per phase		30	A_P
f_i	Input Frequency		50/60	63	Hz
DC Input (from BBU)					
$V_{dc\ nom}$	Nominal Input Voltage		52.5		VAC
V_{dc}	DC Input Voltage Range			53	VAC

5.3 OUTPUT

General Condition: $T_A = 0 \dots 45 \text{ }^\circ\text{C}$ unless otherwise noted.

PARAMETER	DESCRIPTION / CONDITION	MIN	NOM	MAX	UNIT
Main Output V1 (12.6 V)					
$P_{1 \text{ shelf nom}}$	Output Power		6600		W
$I_{1 \text{ shelf nom}}$	Output Current		530		ADC
$C_{V1 \text{ load}}$	Capacitive Loading	0		200	mF
Auxiliary Output VAUX (54 V)					
$P_{\text{AUX shelf nom}}$	Output Power		600		W
$I_{\text{AUX shelf nom}}$	Output Current	0		11.4	A
Battery Charger Output VBC (52.5 V)					
Each BBU is connected separately to a PSU. Ratings see Power Module section					

5.4 SIGNALLING AND CONTROL

5.4.1 OVERVIEW

PARAMETER	DESCRIPTION / CONDITION	CRITERION
Input Signals		
ADD3...5	Address pins for RS485 PSU address for the location of the shelf inside the rack; Referred to RS485 isolated ground	Set by the user via a shelf input connector. See also communication manual BCA.00072
Output Signals		
PWR_FAIL	Signal to flag potential loss of power due to backup timeout; Active low, normally high open collector signal	This signal is pulled low if the PSU is 45s in backup and AC is not yet returned
RED_LOST	Signal to flag loss of redundancy; Active low, normally high open collector signal	This signal is pulled low if at least one PSU or BBU in the shelf has failed, is not operational or is not present. The signal is <u>not</u> pulled low in case of a BAT_PROT or BAT_STOP_DCRG event.
Bidirectional Signals to PSU		
RS485_D / RS485_DN	RS485 communication lines for monitoring of all PSUs; Isolated from other outputs	
Bidirectional Signals		
BAT_I2C_SDA/ BAT_I2C_SCL	I2C communication to the BBU	

5.4.2 LED INDICATOR

The power shelf has a LED on the back side, showing the status of the main 12 V.

PARAMETER	DESCRIPTION / CONDITION	CRITERION
12V LED	Green solid	If main 12 V >10V
	Off	Otherwise

5.5 ELECTROMAGNETIC COMPATIBILITY

5.5.1 IMMUNITY

PARAMETER	DESCRIPTION / CONDITION	CRITERION
ESD Contact Discharge	IEC / EN 61000-4-2, ± 8 kV	A
ESD Air Discharge	IEC / EN 61000-4-2, ± 15 kV	A
EFT / Burst	IEC / EN 61000-4-4, Level 4	A
Surge	IEC / EN 61000-4-5 Differential Mode 2 kV (Line to Neutral) Common Mode 4 kV (Line/Neutral to Earth)	A

5.5.2 EMISSION

PARAMETER	DESCRIPTION / CONDITION	CRITERION
Conducted Emission	FCC Part 15 / EN 55022/ CISPR 22	Class A
Radiated Emission	FCC Part 15 / EN 55022/ CISPR 22	Class A
Harmonic Current Emissions	IEC 61000-3-2 $V_i = 277$ VAC / 60 Hz & 230 VAC / 50 Hz, 100% load	Class A

5.6 SAFETY / APPROVALS

Maximum electric strength testing is performed in the factory according to IEC/EN 60950, and UL 60950. Input-to-output electric strength tests should not be repeated in the field. Bel Power Solutions will not honor any warranty claims resulting from electric strength field tests.

PARAMETER	DESCRIPTION / CONDITION	NOTE
Agency Approvals	UL 60950-1 2 nd Edition CAN/CSA-C22.2 No. 60950-1-07 2 nd Edition IEC 60950-1: 2005 EN 60950-1: 2006 cCSAus CE Mark CB Report & Certificate EU Low Voltage Directive EMC Directive UL94V-0	Approved by independent body (see CE declaration)
Insulation Strength	AC Primary to any Secondary (3000 VAC)	Reinforced
	AC Primary to Chassis GND (1500 VAC / 2121 VDC)	Basic
	Secondary to Chassis GND (100 VDC)	Functional
	RS485 Communication to AC Primary, Secondary and Chassis GND (500 VDC)	Functional
Creepage / Clearance	Primary (L/N) to chassis (PE)	According to safety standards
	AC Primary to secondary	
Production Electrical Strength Test	AC Primary \leftrightarrow Chassis GND, Secondary and RS485	2121 VDC
	Secondary and RS485 \leftrightarrow AC Primary and Chassis GND	100 VDC
	RS485 \leftrightarrow AC Primary, Chassis GND and Secondary	500 VDC
	Ground Continuity Test	35 A

5.7 ENVIRONMENTAL

PARAMETER	DESCRIPTION / CONDITION	MIN	NOM	MAX	UNIT
T _A	Ambient Operating Temperature Power Shelf is able to start at -15°C	-5		+45	°C
T _S	Storage Temperature Non-operational	-40		+70	°C
	Transport. Temperature Short term storage	-55		+85	°C
	Relative Humidity Operation and storage, non-condensing	10		90	%
	Altitude Operational (no derating)	-		3000 10000	m ft
	Shock Operational half-sine 11 ms, 5 shocks, 3 axes			6	g
	Shock Non-Operational half-sine 11 ms, 10 shocks, 3 axes			12	g
	Vibration Operational 1.5 mm amplitude, 5 to 500 Hz, 10 sweeps at 1 octave / minute per each of the three axes			0.5	g
	Vibration Non-Operational 3 mm amplitude, 5 to 500 Hz, 10 sweeps at 1 octave / minute per each of the three axes			1.0	g

5.8 MECHANICAL

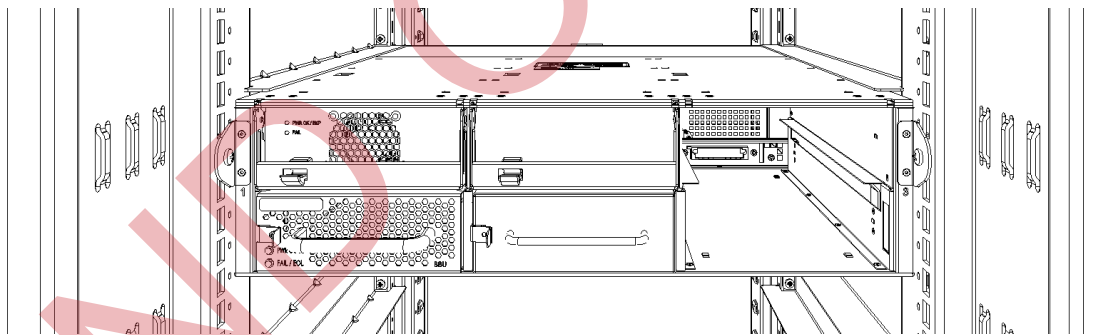
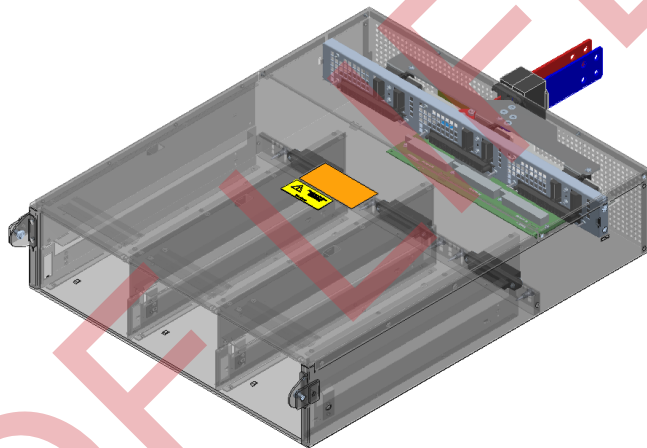
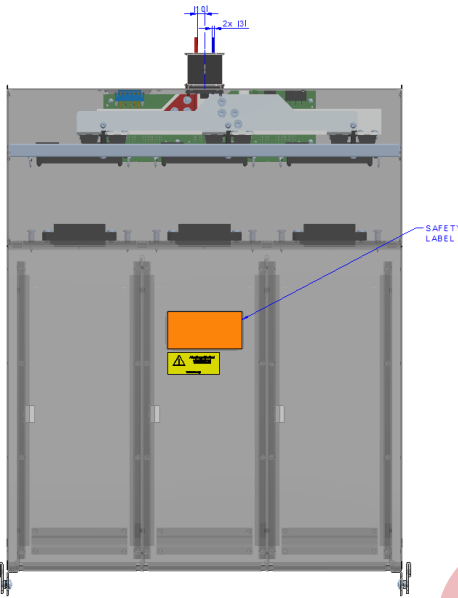
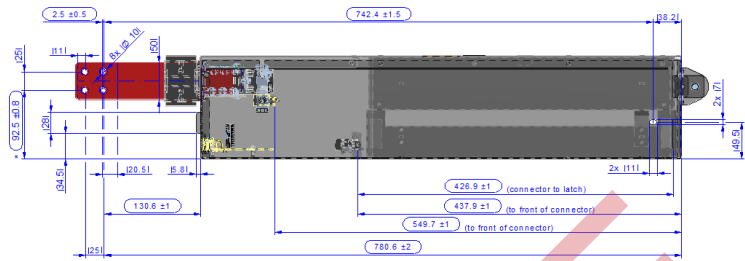
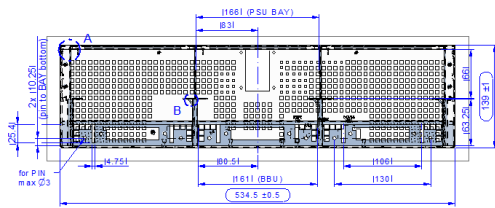

PARAMETER	DESCRIPTION / CONDITION	MIN	NOM	MAX	UNIT
Dimension	Width		534.5		mm
	Height		139		mm
	Depth		780.6		mm
Weight			15.5		kg

V2 Power Module & V2 Power Shelf

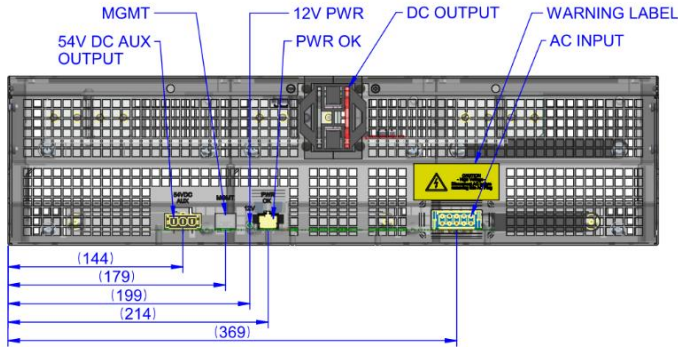

5.9 CONNECTORS

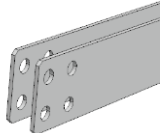
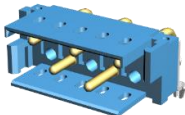

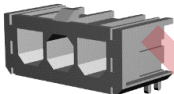
CONNECTOR	PARAMETER	DESCRIPTION / CONDITION	MANUFACTURER P/N	BEL POWER SOLUTION P/N
	V ₁ Output busbar	Main output busbars 3 x 50 x 206.1 mm	-	-
		Mating part	-	-
	AC input connector	5pin Scorpion Power Connector, 90° PCB mount	Positronic	SP5YYE48M0LN9A1/ AA-PA1067
		Mating part	Positronic	SP5YYE1F0091/AA (housing) FC1210P2S/AA (pin)
	PWR_FAIL and RED_LOST 9V connector	2x3 pin Mini-Fit Jr. Power Connector, 90° PCB mount	Molex	39-30-1062
		Mating part	Molex	39-01-2065 (housing) 39-00-0208 (pin)
	RS485 communication, addresses and PWR_FAIL / RED_LOST signals	RJ45 connector, 90° PCB mount	FCI	87180-088LF
		Mating part	Various	RJ45 connector
	Auxiliary output	3 pin Sabre Power Connector, 90° PCB mount	Molex	43160-3103
		Mating part	Molex	44441-2003 (housing) 43375-0001 (pin)

V2 Power Module & V2 Power Shelf

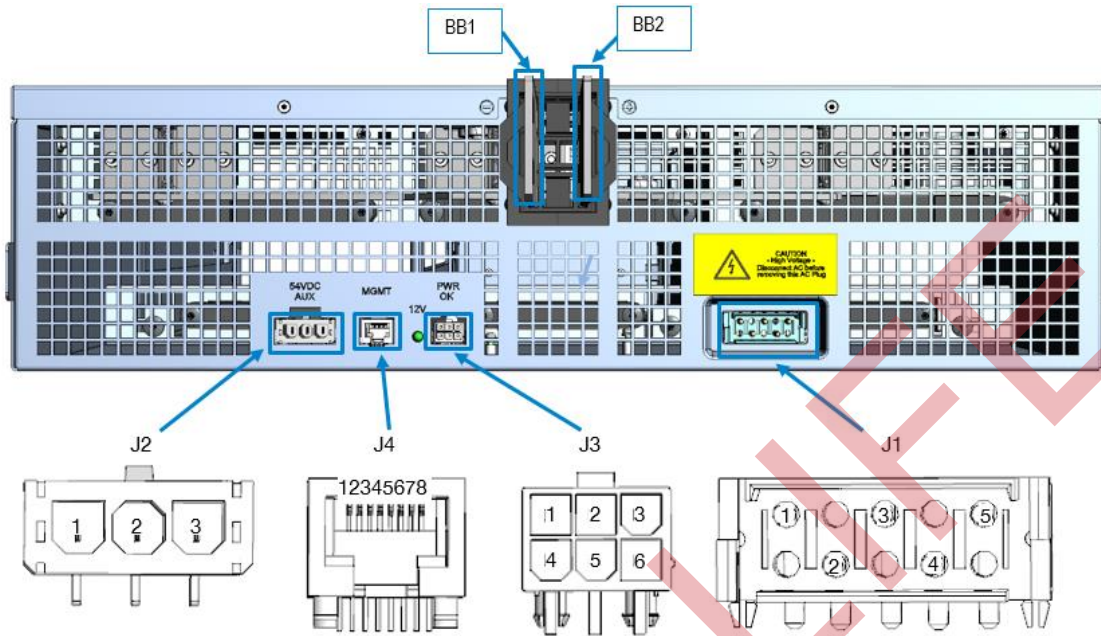

CONNECTOR	PIN	NAME	DESCRIPTION
Power Output			
BB1		V1	Power ground / 12 VDC return
BB2		GR1	+12 VDC main output
J2	1	AUX_54V	+54 VDC auxiliary output
J2	2	AUX_54V_R	54 VDC auxiliary output return
J2	3	PE	protective earth
Power Input			
J1	1	AC_L1	AC input line
J1	2	AC_N	AC input neutral
J1	3	AC_L2	AC input line
J1	4	AC_PE	⊕ AC input protective earth (long pin)
J1	5	AC_L3	AC input line
Signals and Control			
J4	1	485_RTN	RS485 ground
J4	2	PWR_FAIL	Power fail status signal
J4	3	RED_LOST	Redundancy status signal
J4	4	485_D	RS485 Data line
J4	5	485_DN	RS485 Data N line
J4	6	ADD3	Address pin3
J4	7	ADD4	Address pin4
J4	8	ADD5	Address pin5
J3	1, 4	PWR_FAIL_9V	9 V / 1 A output turned on with power fail status signal
J3	2, 5	GR1	Power ground
J3	3, 6	RED_LOST_9V	9 V / 1 A output turned on with redundancy status signal

6. V2 BATTERY BACKUP UNIT

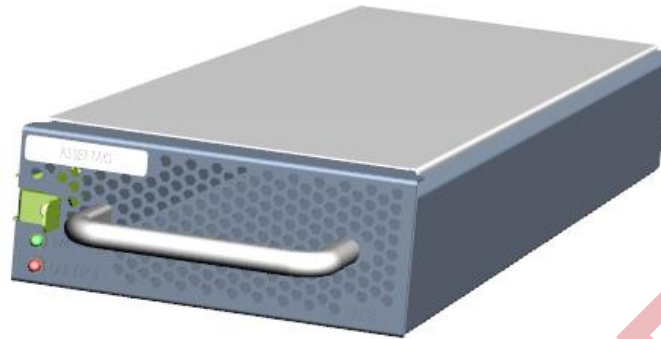

6.1 BBU GENERAL INFORMATION

Please see BBU Manufacturer datasheet for detailed information.

6.2 MECHANICAL

PARAMETER	DESCRIPTION / CONDITION	MIN	NOM	MAX	UNIT
Dimension	Width		160		mm
	Height		62		mm
	Depth		433.7		mm
Weight			5.6		kg

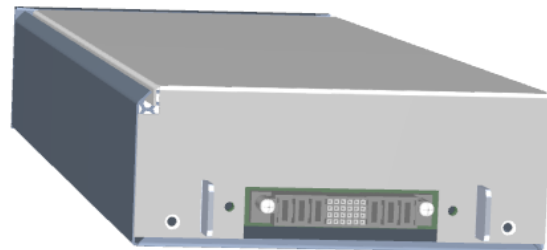
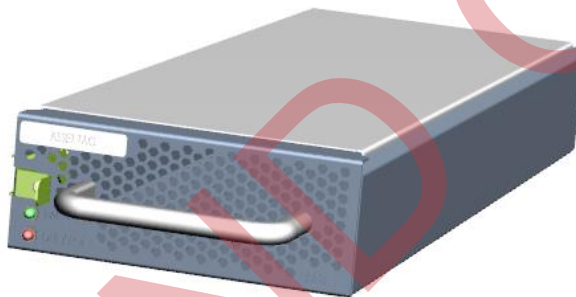

6.3 CONNECTORS

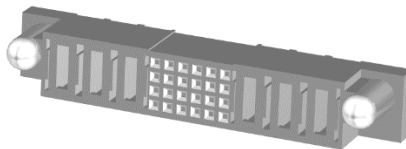

PARAMETER	DESCRIPTION / CONDITION	MANUFACTURER P/N	BEL POWER SOLUTIONS P/N
TBD			



7. V2 ACCESSORIES

ITEM	DESCRIPTION	ORDERING PART NUMBER	SOURCE
	Blank Panel PSU Mechanical blank panel to cover empty PSU slot	SPSFCBK-12BP01	belfuse.com/power-solutions
	Blank Panel BBU Mechanical blank panel to cover empty BBU slot	SPSFCBK-12BP02	belfuse.com/power-solutions

8. GLOSSARY AND ABBREVIATIONS

DOCUMENT NUMBER	DESCRIPTION
AUX	Auxiliary -> used as shortcut for the 300W auxiliary converter
BC	Battery Charger -> used as shortcut for the 270W battery charger converter
BBU	Battery Backup Unit
BKP	Backup
CF	Current Feed -> used as shortcut for the 3600W DC input to HV Bulk converter
CRG	Charge
DCRG	Discharge
EN	Enable
EOL	End of Life
FW	Firmware
HW	Hardware
OT /OTP	Over Temperature (Protection)
OV / OVP	Over Voltage (Protection)
OR	Oring
PF	Power Factor
PFC	Power Factor Correction
SOH	State of Health
SR	Synchronous Rectification
SW	Software
THD	Total Harmonic Distortion
UV / UVP	Under Voltage (Protection)

9. REFERENCES

DOCUMENT NUMBER	DESCRIPTION
BCA.00072	SPAFCBK-11G RS485 Communication Manual
BCM 00366 0	SPAFCBK-11G Installation Instruction
BCM 00367 0	SPSFCBK-18 Installation Instruction
SPSFCBK-18.FD	SPSFCBK-18 Mechanical outline drawing

For more information on these products consult: tech.support@psbel.com

NUCLEAR AND MEDICAL APPLICATIONS - Products are not designed or intended for use as critical components in life support systems, equipment used in hazardous environments, or nuclear control systems.

TECHNICAL REVISIONS - The appearance of products, including safety agency certifications pictured on labels, may change depending on the date manufactured. Specifications are subject to change without notice.