

Model Number	Power Supply Unit & its Installation Type	Power	Voltage	Max. Load (Convection)	Max. Load (300 LFM)	Ripple ¹
LFWLP120-1X01-CK	In CK cover Kit	70 W	12 V	5.83 A		1%
LFWLP120-1X01	In Open Frame					
LFWLP120-1X01-L	With L Bracket	120 W	12 V	8.33 A	10.0 A	1%
LFWLP120-1X01-B	With Base Plate					
LFWLP120-1X01-U	With U channel					
LFWLP120-1X02-CK	In CK cover Kit	70 W	15 V	4.66 A		1%
LFWLP120-1X02	In Open Frame					
LFWLP120-1X02-L	With L Bracket	120 W	15 V	6.66 A	8.0 A	1%
LFWLP120-1X02-B	With Base Plate					
LFWLP120-1X02-U	With U channel					
LFWLP120-1X03-CK	In CK cover Kit	70 W	24 V	2.91 A		1%
LFWLP120-1X03	In Open Frame					
LFWLP120-1X03-L	With L Bracket	120 W	24 V	4.16 A	5.00 A	1%
LFWLP120-1X03-B	With Base Plate					
LFWLP120-1X03-U	With U channel					
LFWLP120-1X04-CK	In CK cover Kit	70 W	48 V	1.46 A		1%
LFWLP120-1X04	In Open Frame					
LFWLP120-1X04-L	With L Bracket	120 W	48 V	2.08 A	2.5 A	1%
LFWLP120-1X04-B	With Base Plate					
LFWLP120-1X04-U	With U channel					
LFWLP120-1X05-CK	In CK cover Kit	70 W	30 V	2.33 A		1%
LFWLP120-1X05	In Open Frame					
LFWLP120-1X05-L	With L Bracket	120 W	30 V	3.33 A	4.0 A	1%
LFWLP120-1X05-B	With Base Plate					
LFWLP120-1X05-U	With U channel					
LFWLP120-1X06-CK	In CK cover Kit	70 W	58 V	1.20 A		1%
LFWLP120-1X06	In Open Frame					
LFWLP120-1X06-L	With L Bracket	120 W	58 V	1.72 A	2.07 A	1%
LFWLP120-1X06-B	With Base Plate					
LFWLP120-1X06-U	With U channel					
For Screw Terminal version replace "X" above with "0", example LFWLP120-1005						
For Header version replace "X" above with "3", example LFWLP120-1305						
LFWLP120-CK metal cover kit accessory available.						

Connectors		
J1	Pin 1	AC LINE
	Pin 2	NOT FITTED
	Pin 3	AC NEUTRAL
J2	Pin 1,2	V1 -VE
	Pin 3,4	V1 +VE

Notes

1. Ripple is peak to peak with 20 MHz bandwidth and 10 μ F (Electrolytic capacitor) in parallel with a 0.1 μ F capacitor at rated line voltage and load ranges.
2. Specifications are for nominal input voltage, 25°C unless otherwise stated.
3. Output ripple can be more than 10% of the output voltage.
4. Functional, not approved.
5. When used in Cover Kit, de-rate output power to 70 % under all operating conditions.
6. For Class II version Enquire with EOS Sales Rep before Order

Mechanical Specifications

AC Input Connector (J1) Option 1	Molex: 39357-0003 Tyco: 2-1776112-3	(J1) Option 2	Molex: 1722861103 (Mating conn: Molex 1722561003) (Mating conn: Molex 1722561103) (Mating conn: Molex 1722563103)
DC Output Connector (J2) Option 1	Molex: 39357-0004 Tyco: 2-1776112-4	(J2) Option 2	Molex: 1722861104 (Mating conn: Molex 1722561004) (Mating conn: Molex 1722561104) (Mating conn: Molex 1722563104)
Dimensions	3 x 2 x 1.18 inches (76.2 x 50.8 x 30.1 mm)		
Weight	200gm Max.		

EMC

Parameter	Conditions/Description	Criteria
Conducted Emissions	EN55032-B, CISPR22-B, FCC PART15-B	Pass
Radiated Emissions	EN 55032 A	Pass Level B with external core (King core K5B RC 25x12x15-M in input cable)
Input Current Harmonics	EN 61000-3-2	Class D
Voltage Fluctuation and Flicker	EN 61000-3-3	Pass
ESD Immunity	EN 61000-4-2	Level 3, Criterion A
Radiated Field Immunity	EN 61000-4-3	Level 3, Criterion A
Electrical Fast Transient Immunity	EN 61000-4-4	Level 3, Criterion A
Surge Immunity	EN 61000-4-5	Level 3, Criterion A
Conducted Immunity	EN 61000-4-6	Level 3, Criterion A
Magnetic Field Immunity	EN 61000-4-8	Level 3, Criterion A
Voltage dips, interruptions	EN 61000-4-11	Criterion A & B

Safety

CE Mark	Complies with LVD Directive
Approval Agency	Nemko, UL, C-UL, CCC
Safety Standard(s)	IEC 62368-1:2018, EN 62368-1:2014;A11, UL 62368-1 and CAN/CSA C22.2 No. 62368-1:19 GB17625.1-2012;GB4943.1-2011;GB/T9254-2008
Safety File Number(s)	Class-I : UL: Certificate Number 20200713-E515384, Nemko: Certificate No. P20224328, CB Certificate No.: NO110825, CCC Certificate No.: 2016010907856054

Environmental

RoHS Version	LFWLP120 series meet RoHS compliance as per european RoHS directive (Directive 2011 / 65 / EU)
--------------	--

Derating Curve

Power de-rating in Open Frame/with L Bracket/ Base Plate/with U channel

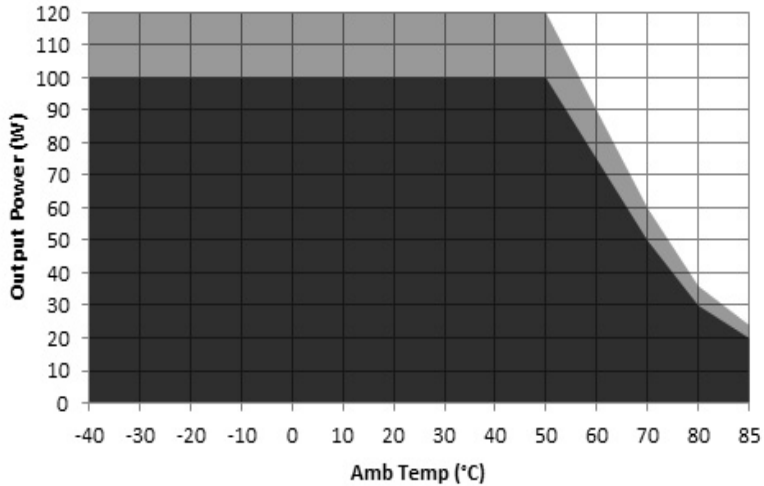

Convection load: 100W up to 50 °C
 De-rate above 50 °C @ 2.5% per °C
 De-rate between 70 °C to 85°C @ 4% per °C

Forced air cooled load : 120W up to 50°C
 De-rate above 50 °C @ 2.5% per °C
 De-rate between 70 °C to 85°C @ 4% per °C

Power de-rating in CK Cover Kit

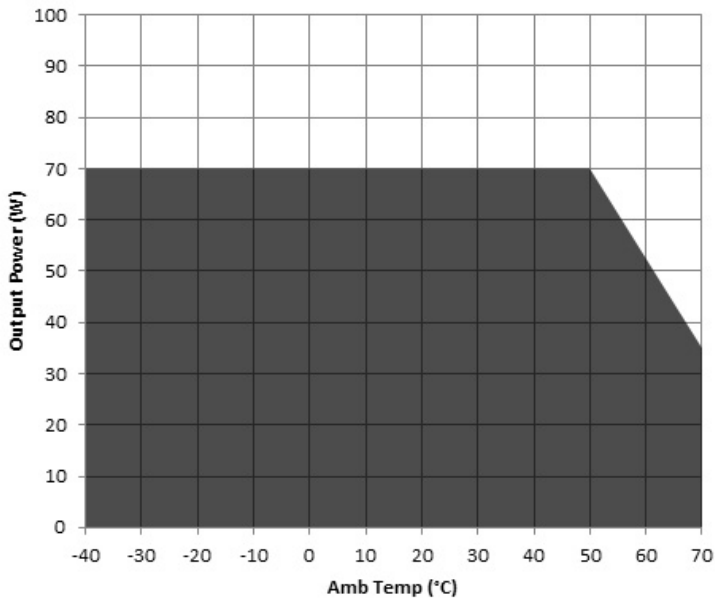

Convection load: 70W up to 50 °C
 De-rate above 50 °C @ 2.5% per °C

Option -1

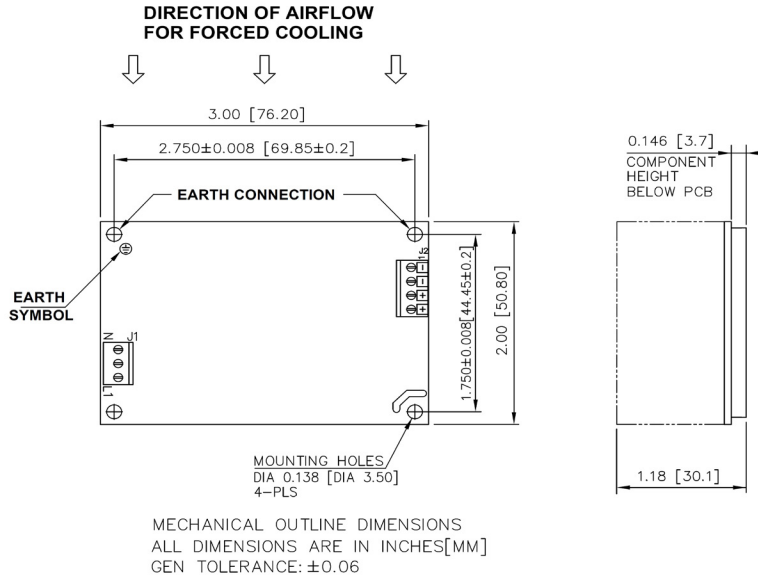

- Notes: In case the PCB is mounted in a metal enclosure, using metal hardware ensure the following
1. Stand off, used to mount PCB has OD of 5.4 mm max.
 2. Screws, used to fix PCB on stand off, have head dia of 6.0 mm max.
 3. Washer, if used, to have dia of 6.5 mm max.

Option -2

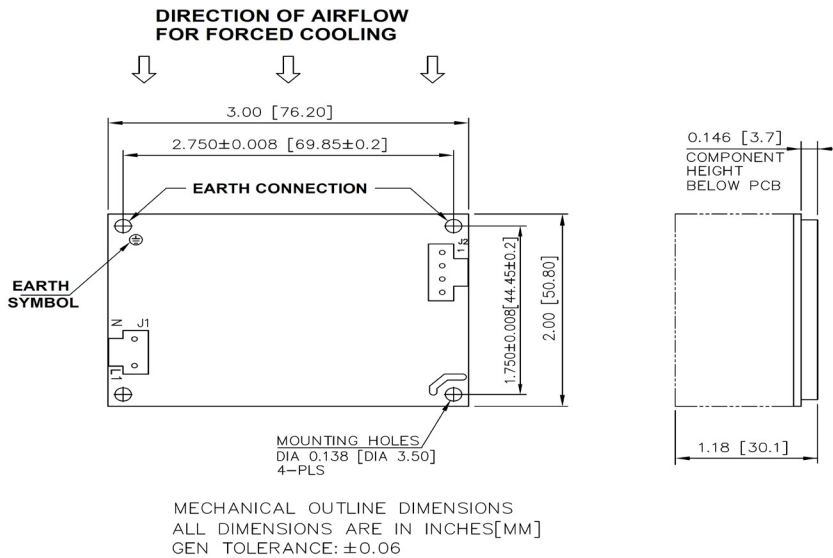

- Notes: In case the PCB is mounted in a metal enclosure, using metal hardware ensure the following
1. Stand off, used to mount PCB has OD of 5.4 mm max.
 2. Screws, used to fix PCB on stand off, have head dia of 6.0 mm max.
 3. Washer, if used, to have dia of 6.5 mm max.

WLP120 WITH BASE PLATE

OPTION-1

OPTION-2

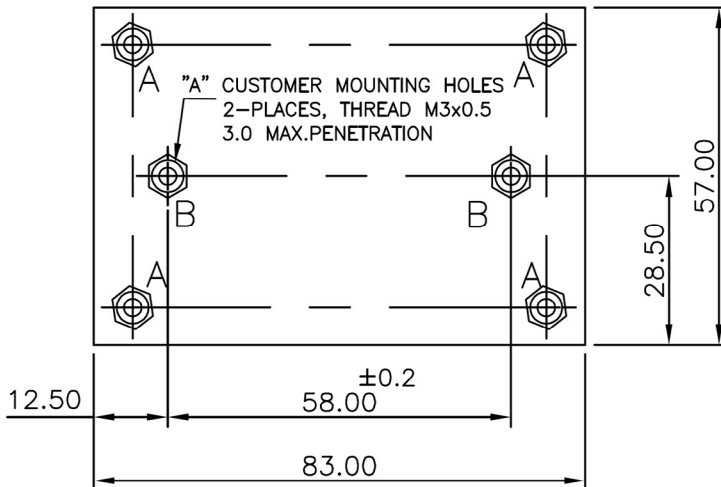
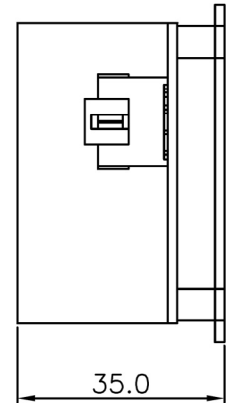
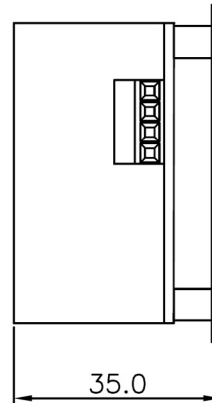
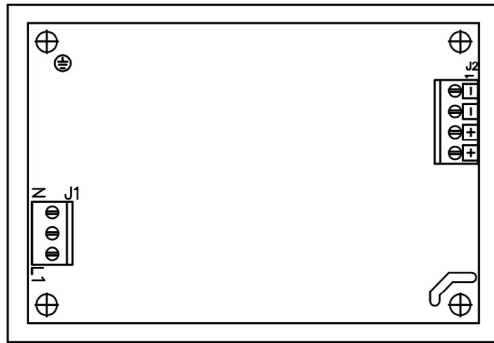

MECHANICAL OUTLINE DIMENSION
ALL DIMENSIONS ARE IN MM
GEN.TOLERANCE: +/-0.5 MM

Notes: In case the PCB is mounted on a metal base plate, using metal hardware ensure the following

1. Stand off, used to mount PCB has OD of 5.4 mm max.
2. Screws, used to fix PCB on stand off, have head dia of 6.0 mm max.
3. Washer, if used, to have dia of 6.5 mm max.

WLP120 SERIES WITH 'L' BRACKET

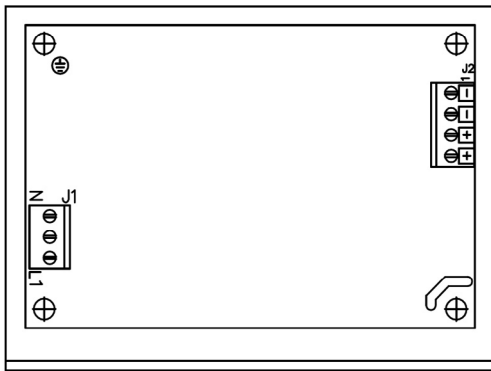

OPTION-1

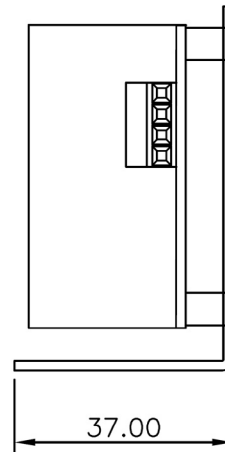

OPTION-2

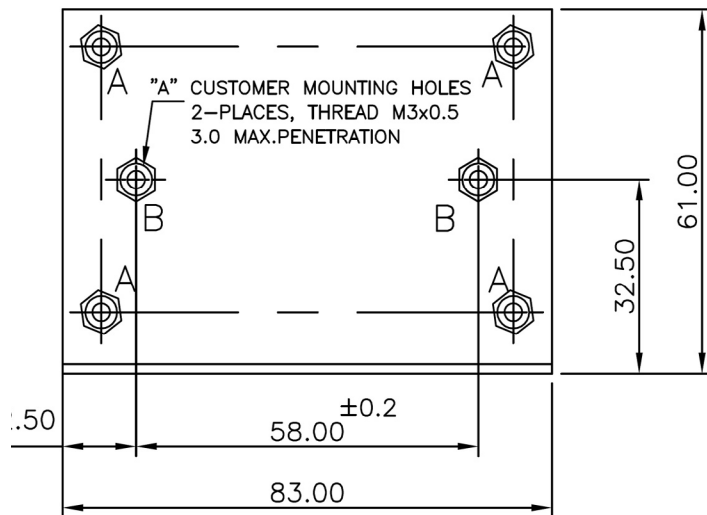
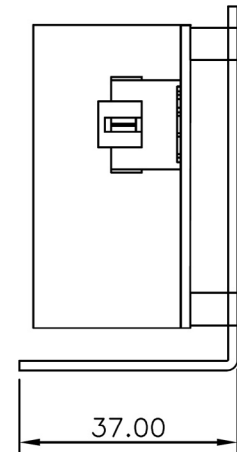

MECHANICAL OUTLINE DIMENS!
ALL DIMENSIONS ARE IN MM
GEN.TOLERANCE: +/-0.5 MM

Notes: In case the PCB is mounted on a metal 'L' bracket, using metal hardware ensure the following

1. Stand off, used to mount PCB has OD of 5.4 mm max.
2. Screws, used to fix PCB on stand off, have head dia of 6.0 mm max.
3. Washer, if used, to have dia of 6.5 mm max.

WLP120 SERIES WITH 'U' CHANNEL

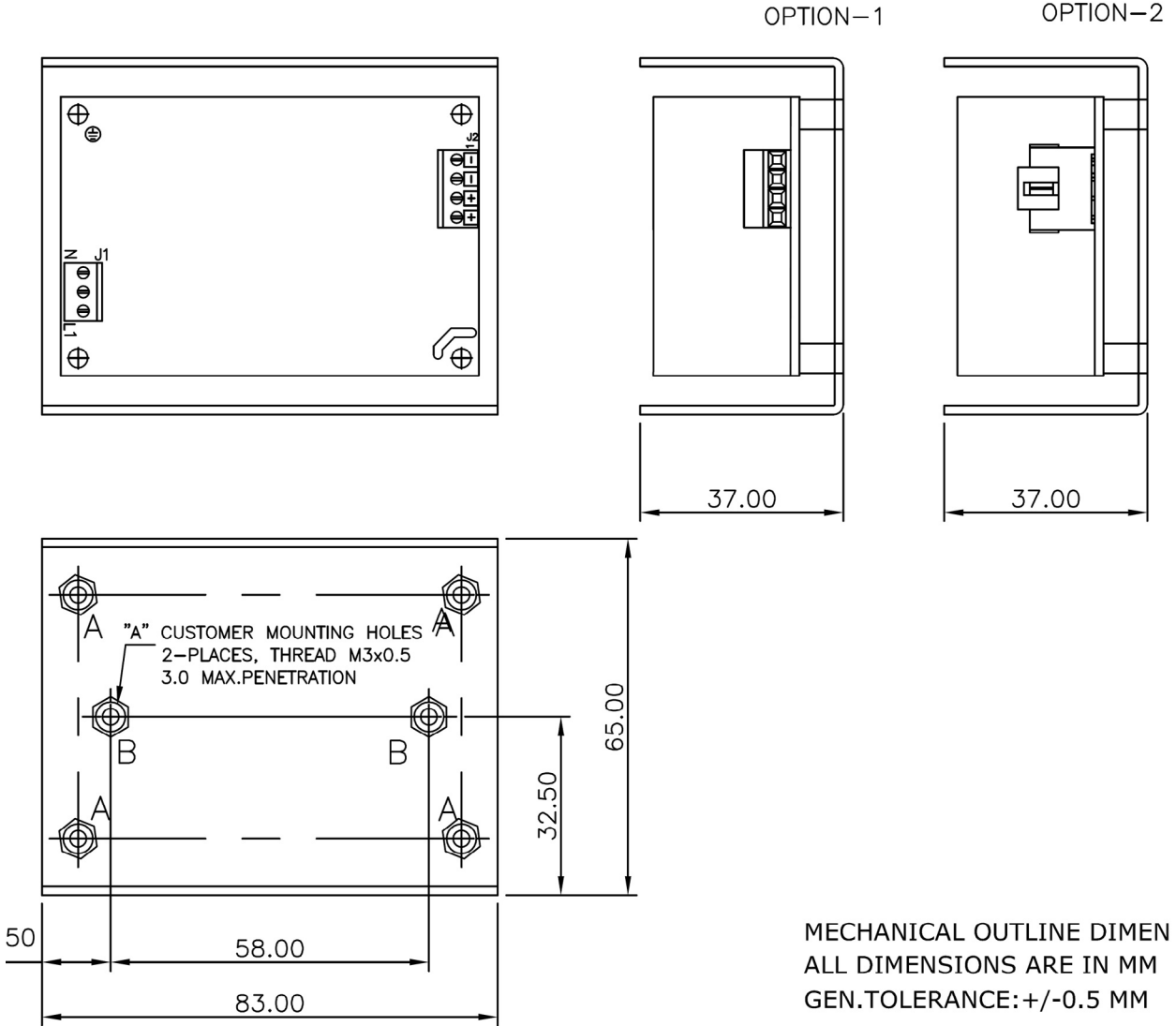

MECHANICAL OUTLINE DIMEN
ALL DIMENSIONS ARE IN MM
GEN.TOLERANCE: +/-0.5 MM

- Notes: In case the PCB is mounted on a metal 'U' Channel, using metal hardware ensure the following1.
1. Stand off, used to mount PCB has OD of 5.4 mm max.
 2. Screws, used to fix PCB on stand off, have head dia of 6.0 mm max.
 3. Washer, if used, to have dia of 6.5 mm max.

WLP120 SERIES WITH COVER KIT

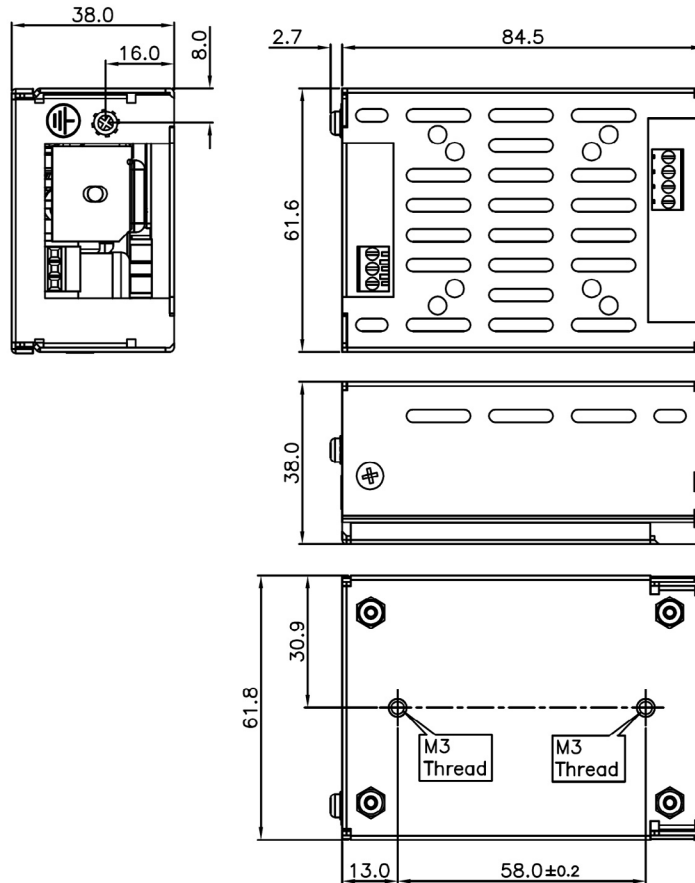

MECHANICAL OUTLINE DIMENSIONS
 ALL DIMENSIONS ARE IN MM
 GEN TOLERANCE: ± 1.0 MM
 MATERIAL: CRCA/GI 1.0MM THICK
 (POWDER COATING/ PASSIVATION/
 ED COATING BLACK)

Notes: In case the PCB is mounted in a metal cover kit, using metal hardware ensure the following

1. Stand off, used to mount PCB has OD of 5.4 mm max.
2. Screws, used to fix PCB on stand off, have head dia of 6.0 mm max.
3. Washer, if used, to have dia of 6.5 mm max.